

13 - 15 GHz 4W Power Amplifier
Ceramic Flange Mounted Package

TGA8659-FL

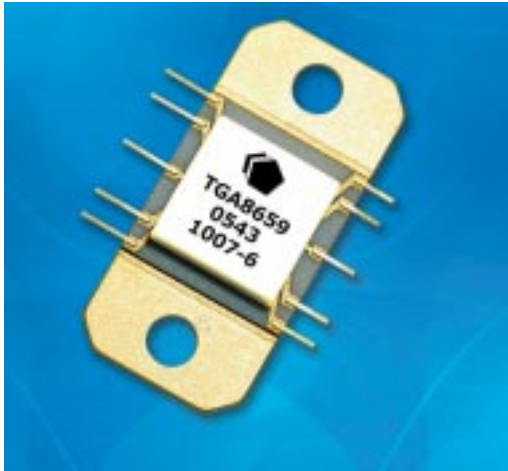

Key Features

- Frequency Range: 13 - 15 GHz
- >25 dB Nominal Gain
- >36 dBm Nominal Psat
- Bias 6 - 7.5V @ 1.3 - 1.6A Idq
- Package Dimensions: 0.33 x 0.70 x 0.12 in
8.4 x 17.8 x 3.0 mm

Primary Applications

- Ku-Band VSAT Transmit
- Point-to-Point Radio

The TriQuint TGA8659-FL is a packaged Power Amplifier delivering more than 4 Watts in the VSAT Band. The power amplifier works over the extended frequency range of 13 to 17 GHz and is designed using TriQuint's proven standard 0.5 um gate pHEMT production process.

The TGA8659-FL provides a nominal gain greater than 25dB with excellent input and output VSWR.

The TGA8659-FL is designed for Ku-Band VSAT transmitters and can also provide high power over a wider frequency band.

Evaluation Boards are available upon request.

Lead-free and RoHS compliant

Fixtured Measured Performance

Bias Conditions: Vd = 7V, Idq = 1.3A ± 5%

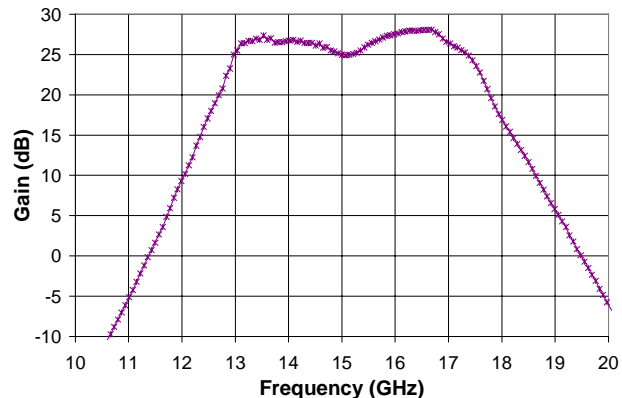

Bias Conditions: Vd = 7V, Idq = 1.3A ± 5%
Frequency at 14.5 GHz

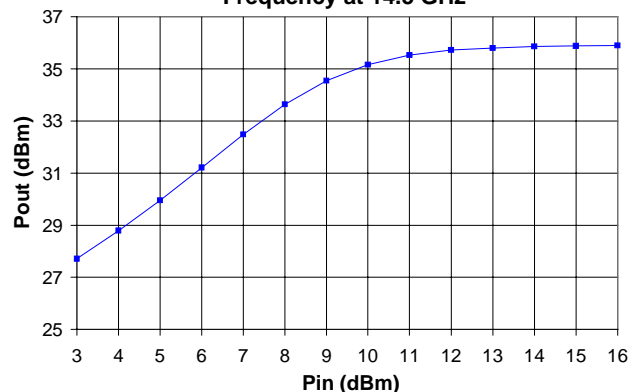

Note: Device is early in the characterization process prior to finalizing all electrical specifications. Specifications are subject to change without notice

TABLE I
MAXIMUM RATINGS 1/

Symbol	Parameter	Value	Notes
V ⁺	Positive Supply Voltage	8V	
I ⁺	Positive Supply Current (Quiescent)	1.7 A	<u>2/</u>
P _D	Power Dissipation	13 W	
P _{IN}	Input Continuous Wave Power	24 dBm	
T _{CH}	Operating Channel Temperature	150 °C	<u>3/</u> , <u>4/</u>
T _M	Mounting Temperature (30 seconds)	260 °C	
T _{STG}	Storage Temperature	-65 °C to 150 °C	

- 1/ These values represent the maximum operable values of this device
2/ Total current for the entire MMIC
3/ These ratings apply to each individual FET
4/ Junction operating temperature will directly affect the device mean time to failure (MTTF). For maximum life it is recommended that junction temperatures be maintained at the lowest possible levels.

TABLE II
ELECTRICAL CHARACTERISTICS
(T_a = 25°C ± 5°C)

Parameter	Units	Typical
Drain Operating Voltage	V	7
Quiescent Current	A	1.3
Small Signal Gain	dB	25
Gain Flatness (Freq = 13.5 - 15 GHz)	dB/100MHz	0.1
Input Return Loss (Linear Small Signal)	dB	10
Output Return Loss (Linear Small Signal)	dB	10
Reverse Isolation	dB	> 50
CW Output Power @P _{sat} at 14.5GHz	dBm	36
TOI at 14.5 GHz with P _{out} /tone of 28 dBm	dBm	41
Power Added Efficiency @P _{sat}	%	30
P1dB temperature coeff. TC (-40 to +70 °C)	dB/deg C	-0.01

Note: Device is early in the characterization process prior to finalizing all electrical specifications. Specifications are subject to change without notice

Measured Fixtured Data

Bias Conditions: $V_d = 7V$, $I_{dq} = 1.3A \pm 5\%$

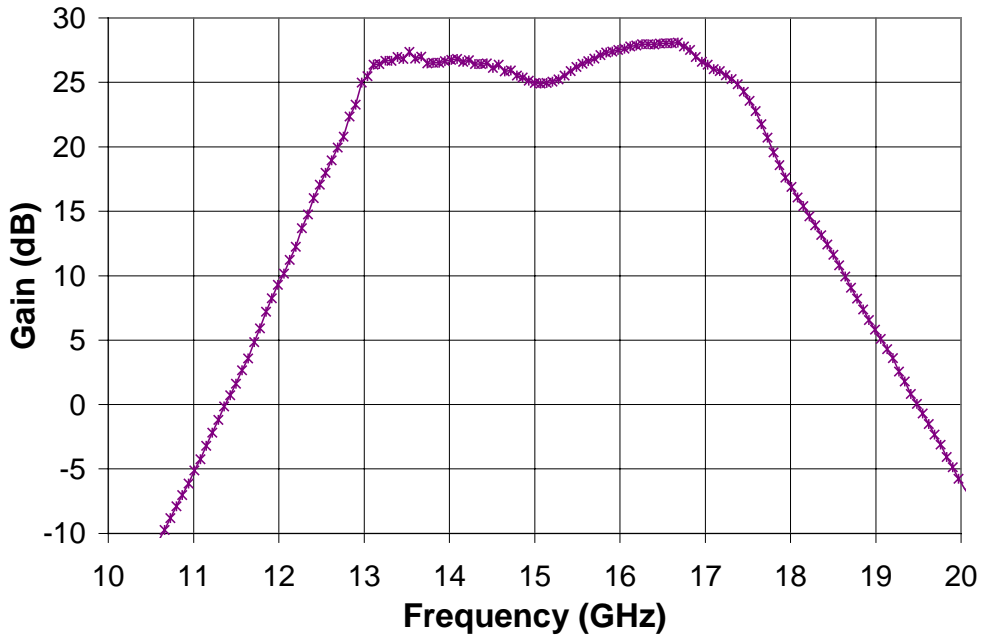

Bias Conditions: $V_d = 7V$, $I_{dq} = 1.3A \pm 5\%$
Frequency at 14.5 GHz

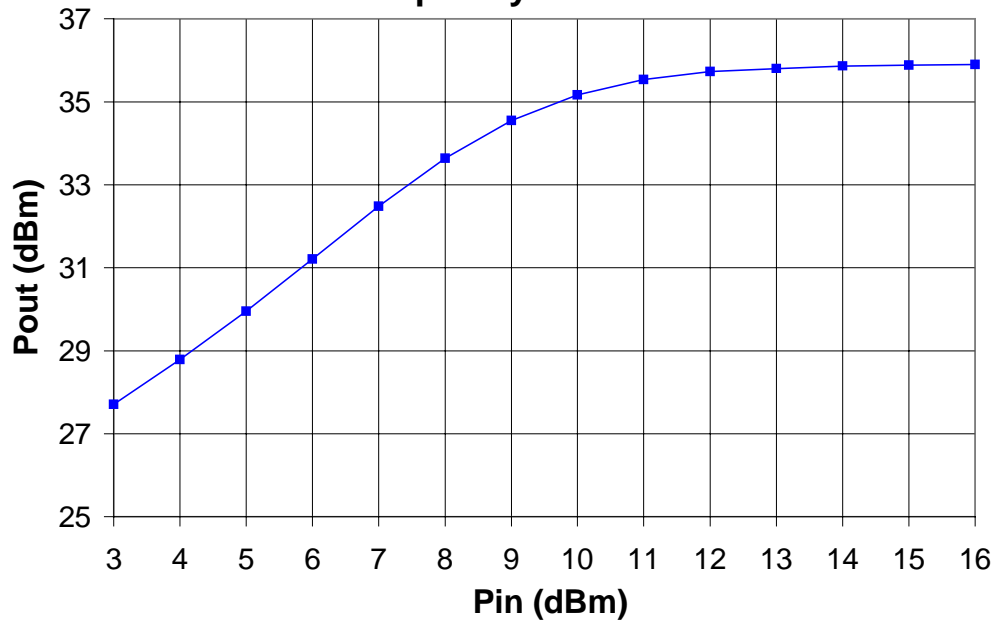

Note: Device is early in the characterization process prior to finalizing all electrical specifications. Specifications are subject to change without notice

Measured Fixtured Data

Bias Conditions: $V_d = 7V$, $I_{dq} = 1.3A \pm 5\%$

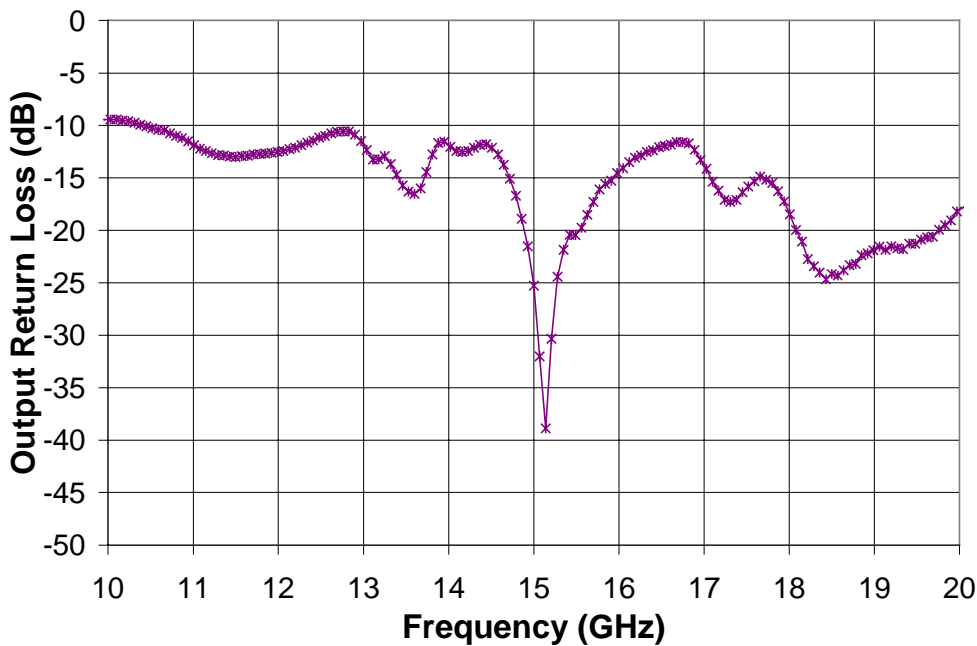
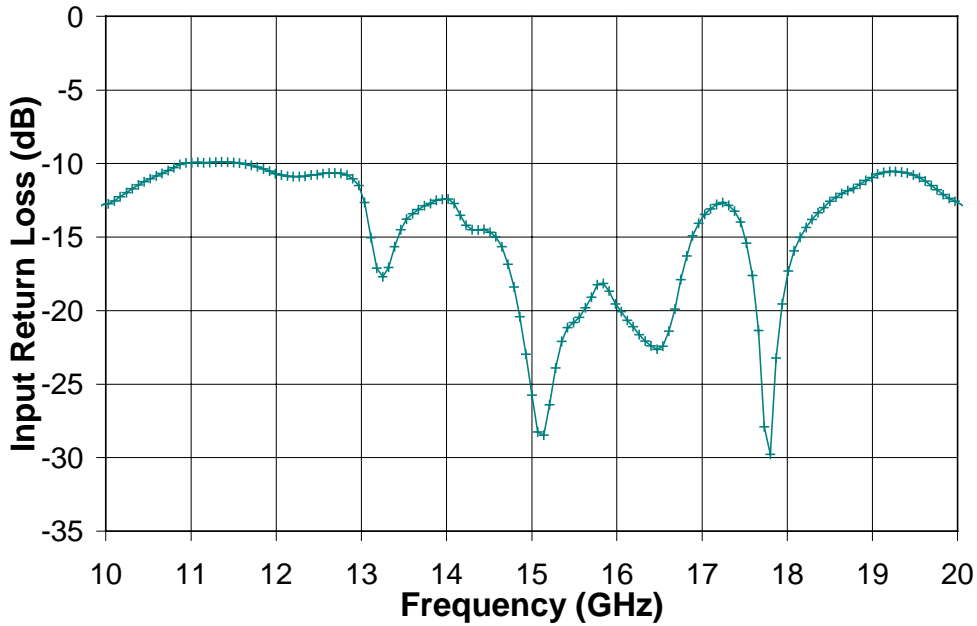

Note: Device is early in the characterization process prior to finalizing all electrical specifications. Specifications are subject to change without notice

Measured Fixtured Data

Bias Conditions: $V_d = 7V, I_{dq} = 1.3A \pm 5\%$

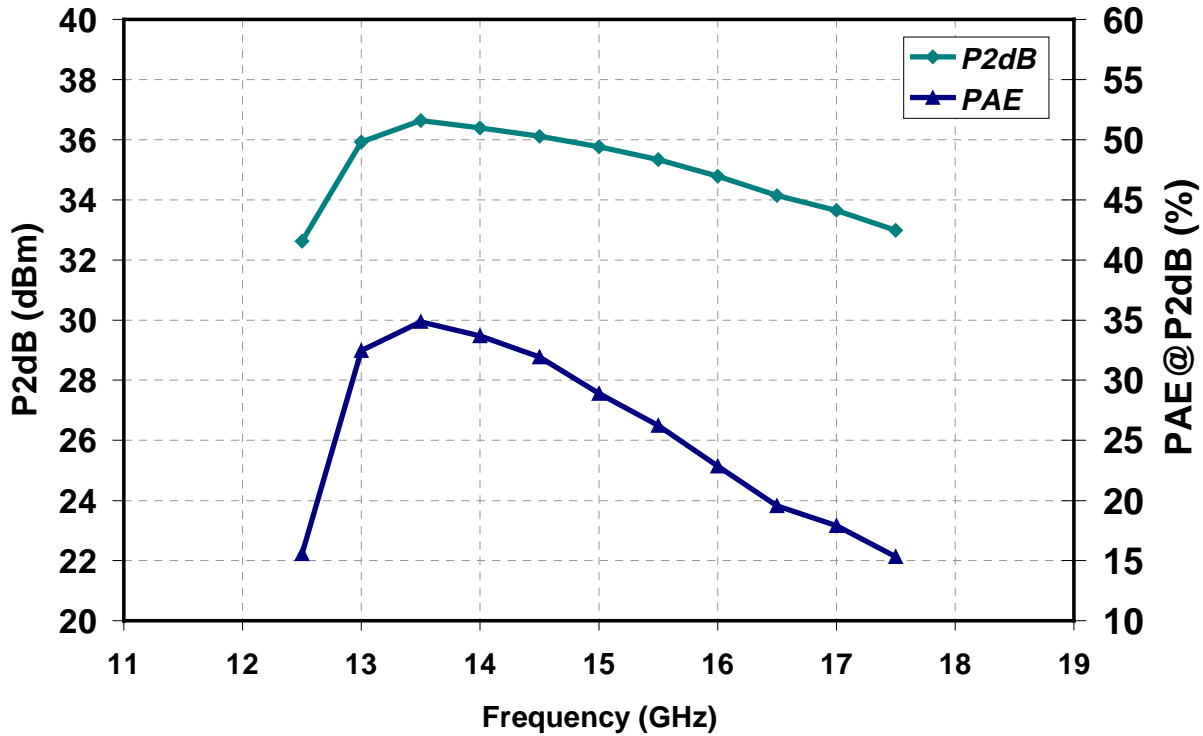

Bias Conditions: $V_d = 6V, I_{dq} = 1.3A \pm 5\%$

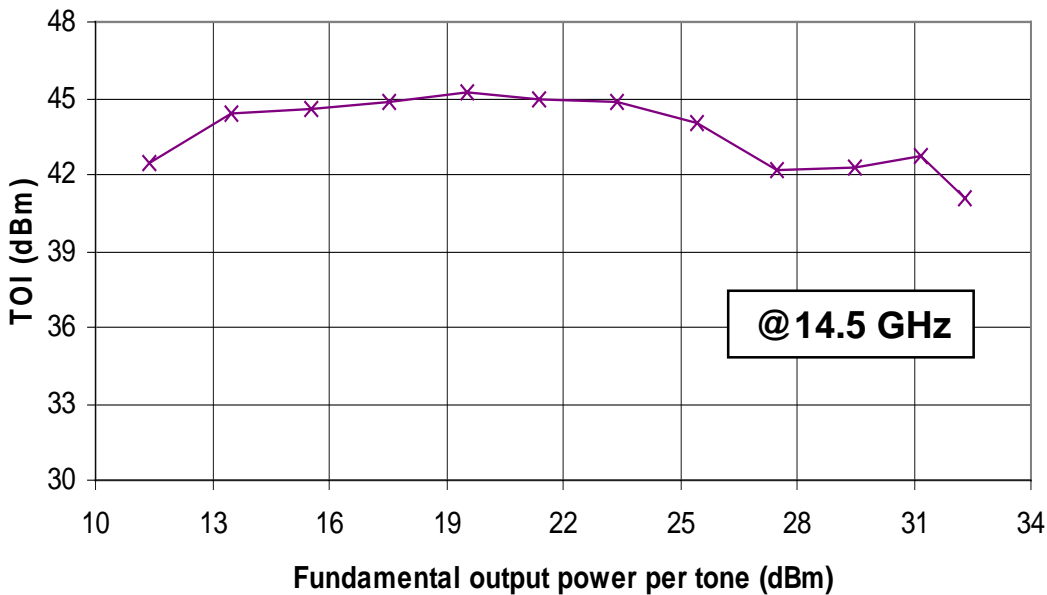

Note: Device is early in the characterization process prior to finalizing all electrical specifications. Specifications are subject to change without notice

Packaged Dimensional Drawing

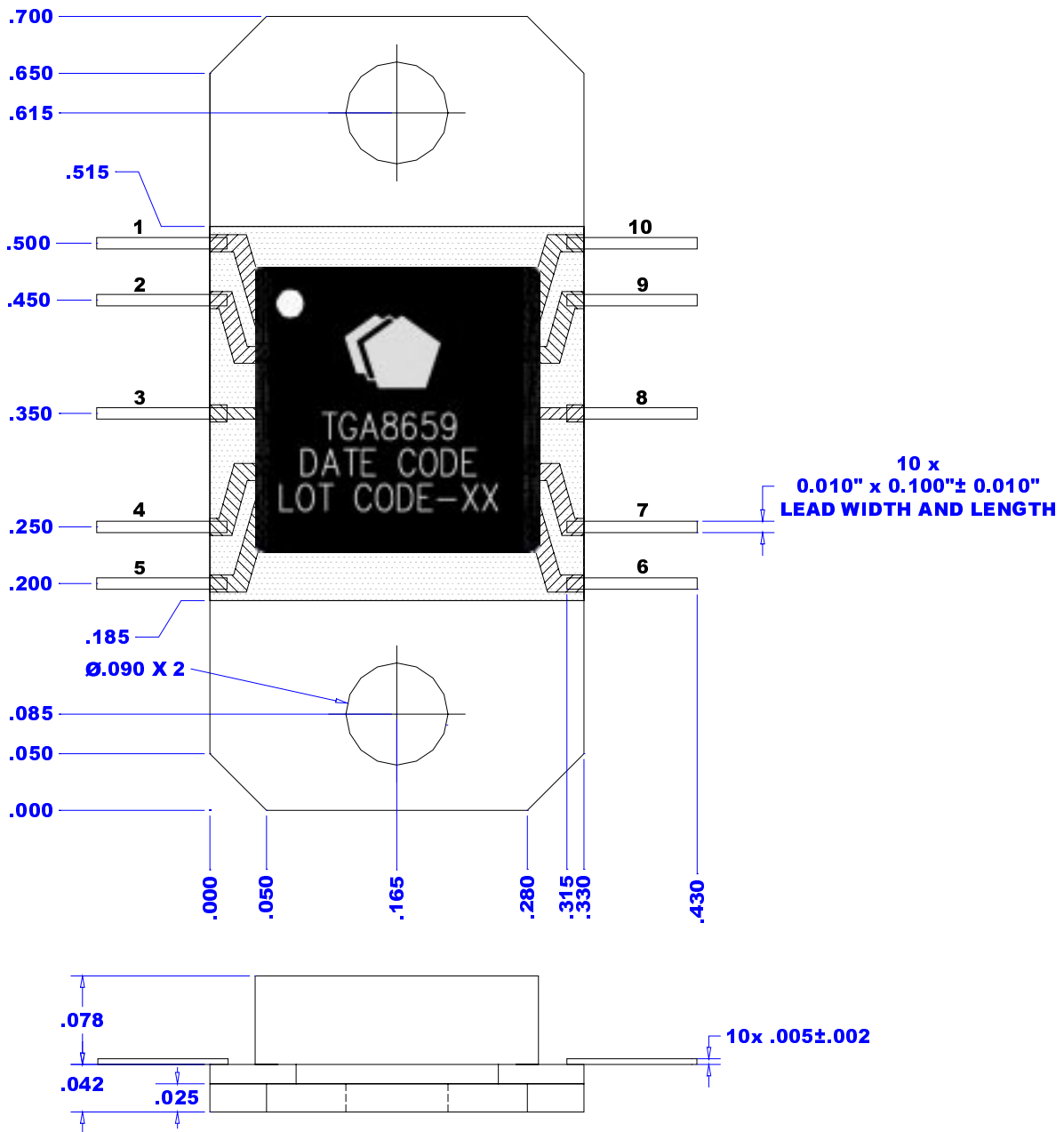

GaAs MMIC devices are susceptible to damage from Electrostatic Discharge. Proper precautions should be observed during handling, assembly and test.

Note: Device is early in the characterization process prior to finalizing all electrical specifications. Specifications are subject to change without notice

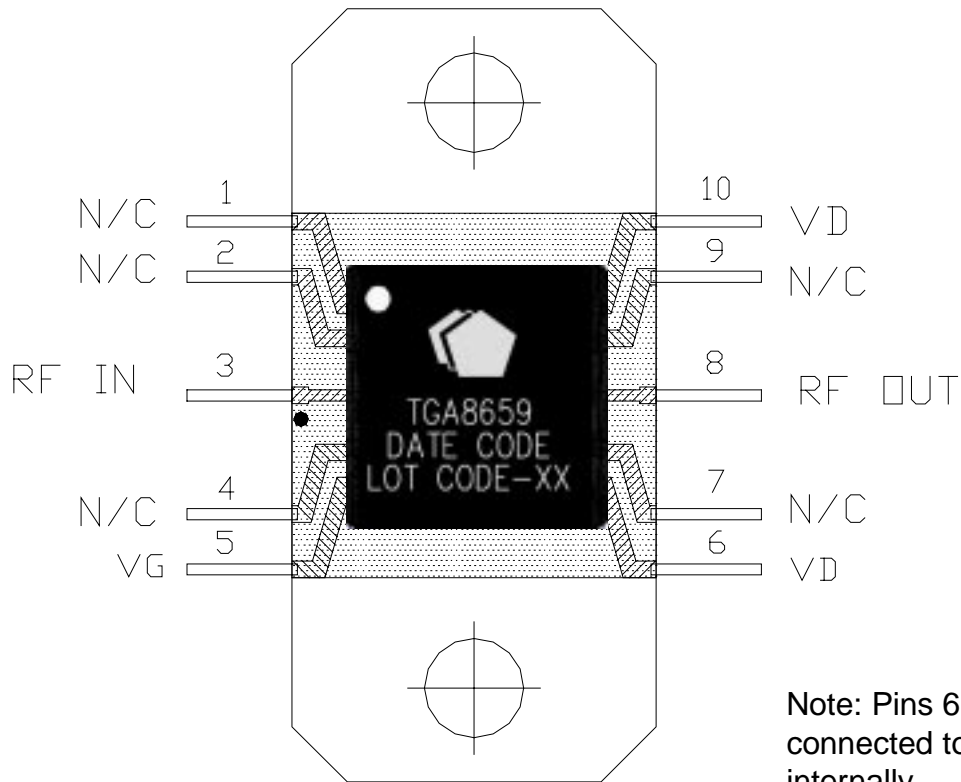

Note: Pins 6 and 10 are connected together internally

Bias Procedure

- 1) Make sure no RF power is applied to the device before continuing.
- 2) Pinch off device by setting V_G to $-1.5V$.
- 3) Raise V_D to $7.0V$ while monitoring drain current.
- 4) Raise V_G until drain current reaches $1.3 A$. V_G should be between $-0.6V$ and $-0.3V$.
- 5) Apply RF power.

Ordering Information

Part	Package Style
TGA8659-FL	Flange, leads bolted down

GaAs MMIC devices are susceptible to damage from Electrostatic Discharge. Proper precautions should be observed during handling, assembly and test.

Note: Device is early in the characterization process prior to finalizing all electrical specifications. Specifications are subject to change without notice

Evaluation Board and Schematic

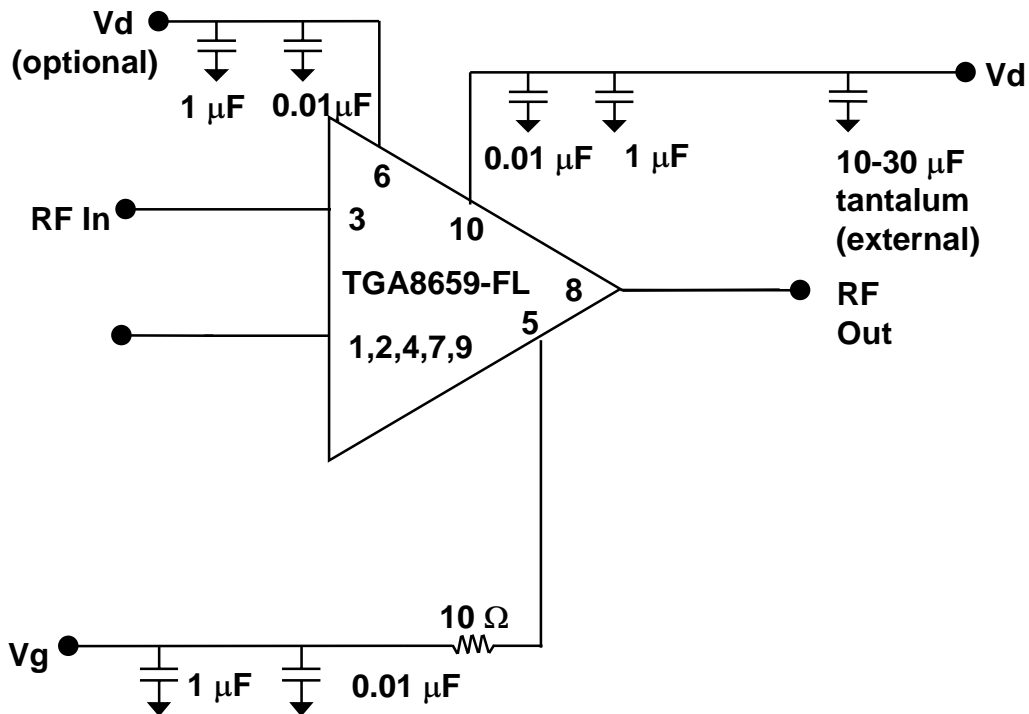
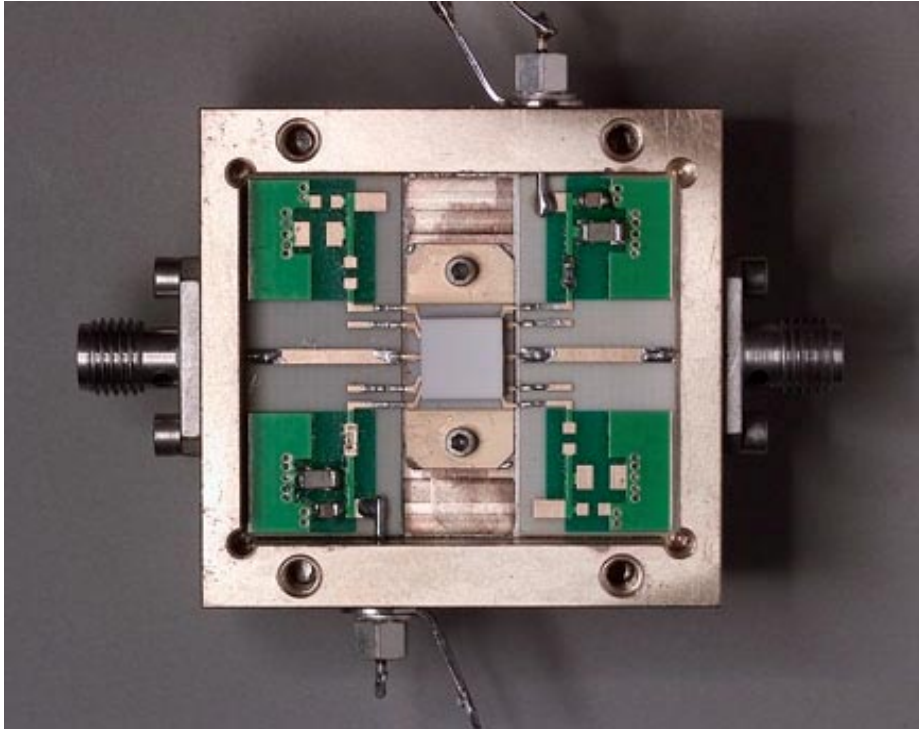

Note: Device is early in the characterization process prior to finalizing all electrical specifications. Specifications are subject to change without notice