

< IGBT MODULES >

CM100MXA-24S

HIGH POWER SWITCHING USE
INSULATED TYPE

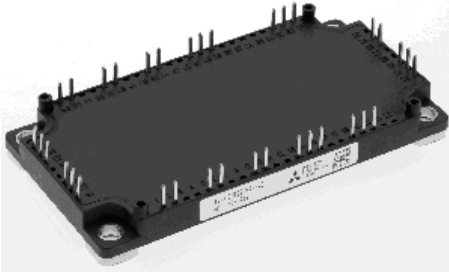

Collector current I_C **1 0 0 A**
 Collector-emitter voltage V_{CES} **1 2 0 0 V**
 Maximum junction temperature T_{jmax} **1 7 5 °C**

- Flat base Type
- Copper base plate (non-plating)
- Tin plating pin terminals
- RoHS Directive compliant
- Recognized under UL1557, File E323585

CIB (Converter+Inverter+Chopper Brake)

APPLICATION

AC Motor Control, Motion/Servo Control, Power supply, etc.

OUTLINE DRAWING & INTERNAL CONNECTION

Dimension in mm

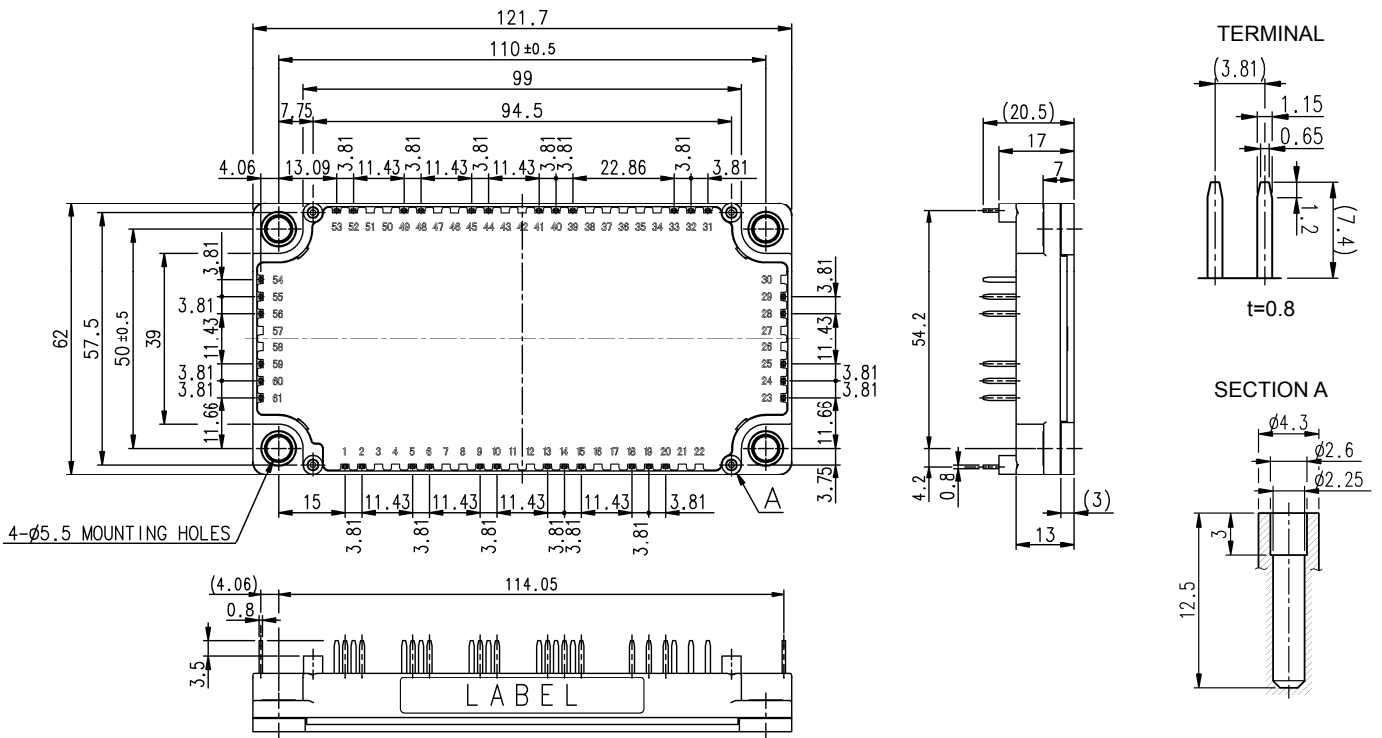

INTERNAL CONNECTION

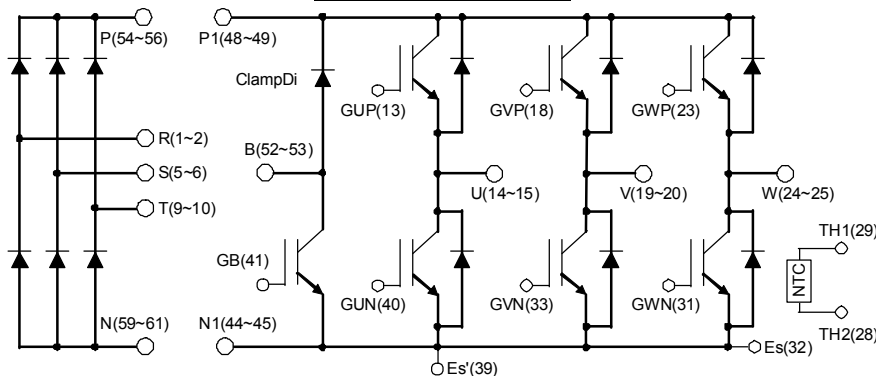

Caution: Each (two or three) pin terminal of P/N/P1/N1/U/V/W/B/R/S/T is connected in the module, but should use all each three pins for the external wiring.

Tolerance otherwise specified

Division of Dimension	Tolerance
0.5 to 3	±0.2
over 3 to 6	±0.3
over 6 to 30	±0.5
over 30 to 120	±0.8
over 120 to 400	±1.2

The tolerance of size between terminals is assumed to be ±0.4.

< IGBT MODULES >

CM100MXA-24S

HIGH POWER SWITCHING USE
INSULATED TYPE

ABSOLUTE MAXIMUM RATINGS (T_J=25 °C, unless otherwise specified)

INVERTER PART IGBT/FWDI

Symbol	Item	Conditions	Rating	Unit
V _{CES}	Collector-emitter voltage	G-E short-circuited	1200	V
V _{GES}	Gate-emitter voltage	C-E short-circuited	±20	V
I _C	Collector current	DC, T _C =119 °C (Note.2, 4)	100	A
I _{CRM}		Pulse, Repetitive (Note.3)	200	
P _{tot}	Total power dissipation	T _C =25 °C (Note.2, 4)	750	W
I _E (Note.1)	Emitter current	T _C =25 °C (Note.2, 4)	100	A
I _{ERM} (Note.1)		Pulse, Repetitive (Note.3)	200	
T _{Jmax}	Maximum junction temperature	-	175	°C

BRAKE PART IGBT/CLAMPDi

Symbol	Item	Conditions	Rating	Unit
V _{CES}	Collector-emitter voltage	G-E short-circuited	1200	V
V _{GES}	Gate-emitter voltage	C-E short-circuited	±20	V
I _C	Collector current	DC, T _C =125 °C (Note.2, 4)	50	A
I _{CRM}		Pulse, Repetitive (Note.3)	100	
P _{tot}	Total power dissipation	T _C =25 °C (Note.2, 4)	425	W
V _{RRM}	Repetitive peak reverse voltage	G-E short-circuited	1200	V
I _F	Forward current	T _C =25 °C (Note.2, 4)	50	A
I _{FRM}		Pulse, Repetitive (Note.3)	100	
T _{Jmax}	Maximum junction temperature	-	175	°C

CONVERTER PART Di

Symbol	Item	Conditions	Rating	Unit
V _{RRM}	Repetitive peak reverse voltage	-	1600	V
E _a	Recommended AC input voltage	RMS	440	V
I _O	DC output current	3-phase full wave rectifying, T _C =125 °C (Note.2)	100	A
I _{FSM}	Surge forward current	The sine half wave 1 cycle peak value, f=60 Hz, non-repetitive	1000	A
I ² t	Current square time	Value for one cycle of surge current	4160	A ² s
T _{Jmax}	Maximum junction temperature	-	150	°C

MODULE

Symbol	Item	Conditions	Rating	Unit
T _{Cmax}	Maximum case temperature	(Note.2)	125	°C
T _{JOP}	Operating junction temperature	-	-40 ~ +150	°C
T _{stg}	Storage temperature	-	-40 ~ +125	
V _{isol}	Isolation voltage	Terminals to base plate, RMS, f=60 Hz, AC 1 min	2500	V

MECHANICAL CHARACTERISTICS

Symbol	Item	Conditions	Limits			Unit
			Min.	Typ.	Max.	
M _s	Mounting torque	Mounting to heat sink M 5 screw	2.5	3.0	3.5	N·m
d _s	Creepage distance	Terminal to terminal	6.47	-	-	mm
		Terminal to base plate	14.27	-	-	
d _a	Clearance	Terminal to terminal	6.47	-	-	mm
		Terminal to base plate	12.33	-	-	
m	Weight	-	-	300	-	g
e _c	Flatness of base plate	On the centerline X, Y (Note.5)	±0	-	+100	µm

< IGBT MODULES >

CM100MXA-24S

HIGH POWER SWITCHING USE
INSULATED TYPE

ELECTRICAL CHARACTERISTICS (T_j=25 °C, unless otherwise specified)
INVERTER PART IGBT/FWDI

Symbol	Item	Conditions	Limits			Unit	
			Min.	Typ.	Max.		
I _{CES}	Collector-emitter cut-off current	V _{CE} =V _{CES} , G-E short-circuited	-	-	1.0	mA	
I _{GES}	Gate-emitter leakage current	V _{GE} =V _{GES} , C-E short-circuited	-	-	0.5	μA	
V _{GE(th)}	Gate-emitter threshold voltage	I _C =10 mA, V _{CE} =10 V	5.4	6.0	6.6	V	
V _{CEsat}	Collector-emitter saturation voltage	I _C =100 A ^(Note.6) , V _{GE} =15 V, (Terminal)	T _j =25 °C	-	1.80	2.25	V
			T _j =125 °C	-	2.00	-	
			T _j =150 °C	-	2.05	-	
		I _C =100 A ^(Note.6) , V _{GE} =15 V, (Chip)	T _j =25 °C	-	1.70	2.15	V
			T _j =125 °C	-	1.90	-	
			T _j =150 °C	-	1.95	-	
C _{ies}	Input capacitance	V _{CE} =10 V, G-E short-circuited	-	-	10	nF	
C _{oes}	Output capacitance		-	-	2.0		
C _{res}	Reverse transfer capacitance		-	-	0.17		
Q _G	Gate charge	V _{CC} =600 V, I _C =100 A, V _{GE} =15 V	-	233	-	nC	
t _{d(on)}	Turn-on delay time	V _{CC} =600 V, I _C =100 A, V _{GE} =±15 V, R _G =6.2 Ω, Inductive load	-	-	300	ns	
t _r	Rise time		-	-	200		
t _{d(off)}	Turn-off delay time		-	-	600		
t _f	Fall time		-	-	300		
V _{EC} ^(Note.1)	Emitter-collector voltage	I _E =100 A ^(Note.6) , G-E short-circuited, (Terminal)	T _j =25 °C	-	1.80	2.25	V
			T _j =125 °C	-	1.80	-	
			T _j =150 °C	-	1.80	-	
		I _E =100 A ^(Note.6) , G-E short-circuited, (Chip)	T _j =25 °C	-	1.70	2.15	V
			T _j =125 °C	-	1.70	-	
			T _j =150 °C	-	1.70	-	
t _{rr} ^(Note.1)	Reverse recovery time	V _{CC} =600 V, I _E =100 A, V _{GE} =±15 V, R _G =6.2 Ω, Inductive load	-	-	300	ns	
Q _{rr} ^(Note.1)	Reverse recovery charge	R _G =6.2 Ω, Inductive load	-	5.3	-	μC	
E _{on}	Turn-on switching energy per pulse	V _{CC} =600 V, I _C =I _E =100 A,	-	8.6	-	mJ	
E _{off}	Turn-off switching energy per pulse	V _{GE} =±15 V, R _G =6.2 Ω, T _j =150 °C,	-	10.7	-		
E _{rr} ^(Note.1)	Reverse recovery energy per pulse	Inductive load	-	10.2	-		
R _{CC'+EE'}	Internal lead resistance	Main terminals-chip, per switch, T _C =25 °C ^(Note.2)	-	-	3.5	mΩ	
r _g	Internal gate resistance	Per switch	-	0	-	Ω	

BRAKE PART IGBT/CLAMPDI

Symbol	Item	Conditions	Limits			Unit	
			Min.	Typ.	Max.		
I _{CES}	Collector-emitter cut-off current	V _{CE} =V _{CES} , G-E short-circuited	-	-	1.0	mA	
I _{GES}	Gate-emitter leakage current	V _{GE} =V _{GES} , C-E short-circuited	-	-	0.5	μA	
V _{GE(th)}	Gate-emitter threshold voltage	I _C =5 mA, V _{CE} =10 V	5.4	6.0	6.6	V	
V _{CEsat}	Collector-emitter saturation voltage	I _C =50 A ^(Note.6) , V _{GE} =15 V, (Terminal)	T _j =25 °C	-	1.80	2.25	V
			T _j =125 °C	-	2.00	-	
			T _j =150 °C	-	2.05	-	
		I _C =50 A ^(Note.6) , V _{GE} =15 V, (Chip)	T _j =25 °C	-	1.70	2.15	V
			T _j =125 °C	-	1.90	-	
			T _j =150 °C	-	1.95	-	
C _{ies}	Input capacitance	V _{CE} =10 V, G-E short-circuited	-	-	5.0	nF	
C _{oes}	Output capacitance		-	-	1.0		
C _{res}	Reverse transfer capacitance		-	-	0.08		
Q _G	Gate charge	V _{CC} =600 V, I _C =50 A, V _{GE} =15 V	-	117	-	nC	

< IGBT MODULES >

CM100MXA-24S

HIGH POWER SWITCHING USE
INSULATED TYPE

ELECTRICAL CHARACTERISTICS (cont.; $T_j=25\text{ }^\circ\text{C}$, unless otherwise specified)

BRAKE PART IGBT/CLAMPDi

Symbol	Item	Conditions	Limits			Unit	
			Min.	Typ.	Max.		
$t_{d(on)}$	Turn-on delay time	$V_{CC}=600\text{ V}$, $I_C=50\text{ A}$, $V_{GE}=\pm 15\text{ V}$, $R_G=13\text{ }\Omega$, Inductive load	-	-	300	ns	
t_r	Rise time		-	-	200		
$t_{d(off)}$	Turn-off delay time		-	-	600		
t_f	Fall time		-	-	300		
V_F	Forward voltage	$I_F=50\text{ A}$ (Note.6), G-E short-circuited, (Terminal)	$T_j=25\text{ }^\circ\text{C}$	-	1.80	2.25	V
			$T_j=125\text{ }^\circ\text{C}$	-	1.80	-	
			$T_j=150\text{ }^\circ\text{C}$	-	1.80	-	
		$I_F=50\text{ A}$ (Note.6), G-E short-circuited, (Chip)	$T_j=25\text{ }^\circ\text{C}$	-	1.70	2.15	V
			$T_j=125\text{ }^\circ\text{C}$	-	1.70	-	
			$T_j=150\text{ }^\circ\text{C}$	-	1.70	-	
t_{rr}	Reverse recovery time	$V_{CC}=600\text{ V}$, $I_F=50\text{ A}$, $V_{GE}=\pm 15\text{ V}$,	-	-	300	ns	
Q_{rr}	Reverse recovery charge	$R_G=13\text{ }\Omega$, Inductive load	-	2.7	-	μC	
E_{on}	Turn-on switching energy per pulse	$V_{CC}=600\text{ V}$, $I_C=I_F=50\text{ A}$,	-	5.5	-	mJ	
E_{off}	Turn-off switching energy per pulse	$V_{GE}=\pm 15\text{ V}$, $R_G=13\text{ }\Omega$, $T_j=150\text{ }^\circ\text{C}$,	-	5.3	-		
E_{rr}	Reverse recovery energy per pulse	Inductive load	-	4.5	-	mJ	
r_g	Internal gate resistance	-	-	0	-	Ω	

CONVERTER PART CONVDi

Symbol	Item	Conditions	Limits			Unit
			Min.	Typ.	Max.	
I_{RRM}	Repetitive peak reverse current	$V_R=V_{RRM}$, $T_j=150\text{ }^\circ\text{C}$	-	-	20	mA
V_F (Terminal)	Forward voltage	$I_F=100\text{ A}$ (Note.6)	-	1.28	1.8	V

NTC THERMISTOR PART

Symbol	Item	Conditions	Limits			Unit
			Min.	Typ.	Max.	
R_{25}	Zero-power resistance	$T_C=25\text{ }^\circ\text{C}$ (Note.2)	4.85	5.00	5.15	k Ω
$\Delta R/R$	Deviation of resistance	$T_C=100\text{ }^\circ\text{C}$, $R_{100}=493\text{ }\Omega$	-7.3	-	+7.8	%
$B_{(25/50)}$	B-constant	Approximate by equation (Note.7)	-	3375	-	K
P_{25}	Power dissipation	$T_C=25\text{ }^\circ\text{C}$ (Note.2)	-	-	10	mW

THERMAL RESISTANCE CHARACTERISTICS

Symbol	Item	Conditions	Limits			Unit
			Min.	Typ.	Max.	
$R_{th(j-c)Q}$	Thermal resistance (Note.2)	Junction to case, per Inverter IGBT	-	-	0.20	K/W
$R_{th(j-c)D}$		Junction to case, per Inverter FWDi	-	-	0.29	
$R_{th(j-c)Q}$		Junction to case, per Brake IGBT	-	-	0.35	K/W
$R_{th(j-c)D}$		Junction to case, per Brake ClampDi	-	-	0.63	
$R_{th(j-c)D}$		Junction to case, per Converter ConvDi	-	-	0.24	
$R_{th(c-s)}$	Contact thermal resistance (Note.2)	Case to heat sink, per 1 module, Thermal grease applied (Note.8)	-	15	-	K/kW

< IGBT MODULES >
CM100MXA-24S
HIGH POWER SWITCHING USE
INSULATED TYPE

- Note.1: Represent ratings and characteristics of the anti-parallel, emitter-collector free wheeling diode (FWDi).
 2: Case temperature (T_c) and heat sink temperature (T_s) are defined on the each surface (mounting side) of base plate and heat sink just under the chips. Refer to the figure of chip location.
 3: Pulse width and repetition rate should be such that the device junction temperature (T_j) dose not exceed T_{jmax} rating.
 4: Junction temperature (T_j) should not increase beyond T_{jmax} rating.
 5: The base plate (mounting side) flatness measurement points (X, Y) are as follows of the following figure.

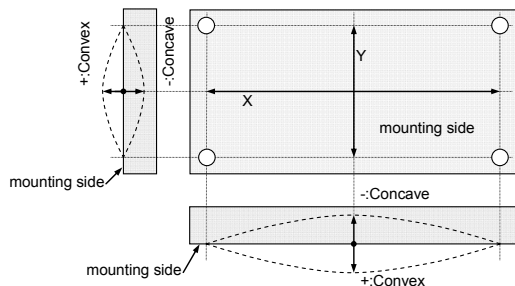

- 6: Pulse width and repetition rate should be such as to cause negligible temperature rise. Refer to the figure of test circuit.
 7: $B_{(25/50)} = \ln\left(\frac{R_{25}}{R_{50}}\right) / \left(\frac{1}{T_{25}} - \frac{1}{T_{50}}\right)$,
 R_{25} : resistance at absolute temperature T_{25} [K]; $T_{25}=25 [^{\circ}\text{C}]+273.15=298.15$ [K]
 R_{50} : resistance at absolute temperature T_{50} [K]; $T_{50}=50 [^{\circ}\text{C}]+273.15=323.15$ [K]
 8: Typical value is measured by using thermally conductive grease of $\lambda=0.9$ W/(m·K).
 9: Use the following screws when mounting the printed circuit board (PCB) on the stand offs.
 "M2.6×10 or M2.6×12 self tapping screw"
 The length of the screw depends on the thickness of the PCB.

RECOMMENDED OPERATING CONDITIONS ($T_a=25^{\circ}\text{C}$)

Symbol	Item	Conditions	Limits			Unit
			Min.	Typ.	Max.	
V_{CC}	(DC) Supply voltage	Applied across P-N/P1-N1 terminals	-	600	850	V
V_{GEon}	Gate (-emitter drive) voltage	Applied across GB-Es1/ G*P-*/G*N-Es(*=U, V, W) terminals	13.5	15.0	16.5	V
R_G	External gate resistance	Per switch				Ω
		Inverter IGBT	6.2	-	62	
		Brake IGBT	13	-	130	

< IGBT MODULES >
CM100MXA-24S
 HIGH POWER SWITCHING USE
 INSULATED TYPE

CHIP LOCATION (Top view)

Dimension in mm, tolerance: ±1 mm

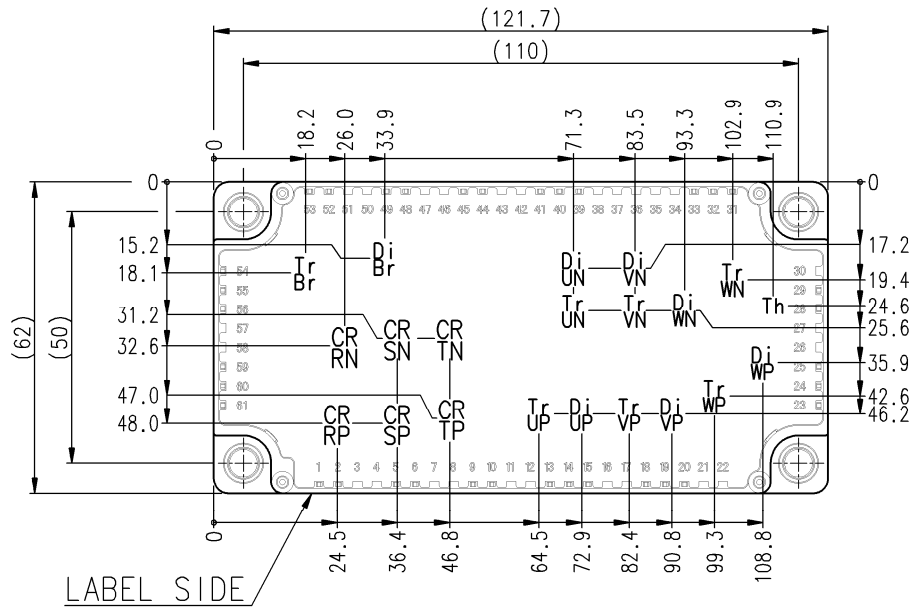

Tr*P/Tr*N/TrBr: IGBT, Di*P/Di*N: FWDi (*=U/V/W), DiBr: ClampDi, CR*P/CR*N: ConvDi (*=R/S/T), Th: NTC thermistor

TEST CIRCUIT AND WAVEFORMS

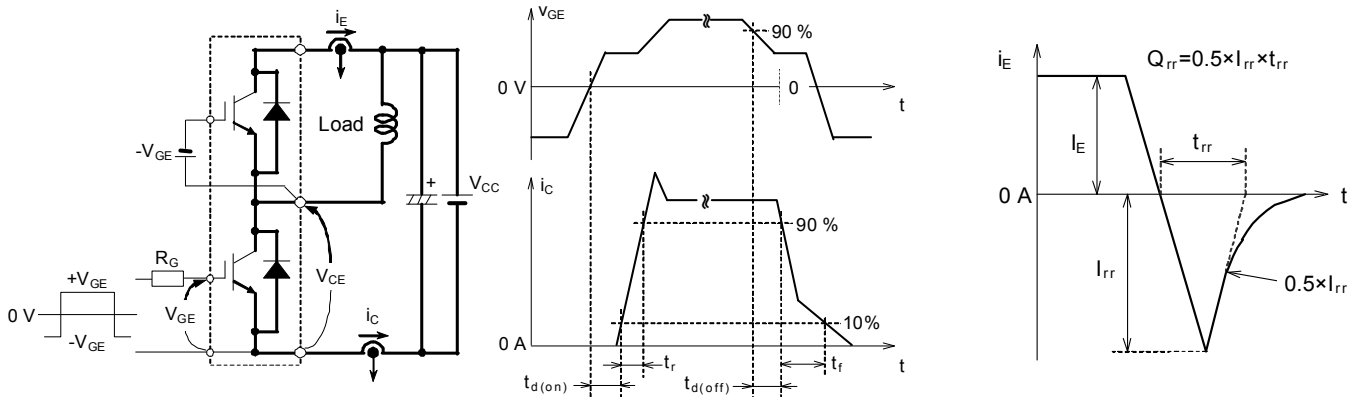

Switching characteristics test circuit and waveforms

t_{rr} , Q_{rr} test waveform

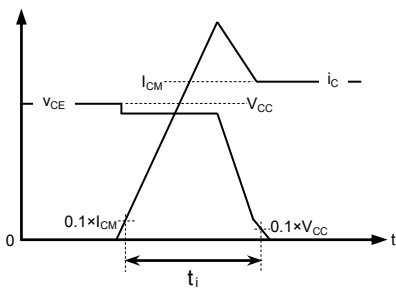

IGBT Turn-on switching energy

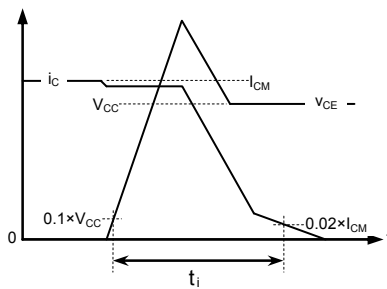

IGBT Turn-off switching energy

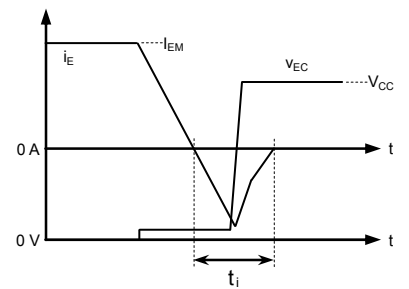

FWDi Reverse recovery energy

Turn-on / Turn-off switching energy and Reverse recovery energy test waveforms (Integral time instruction drawing)

TEST CIRCUIT

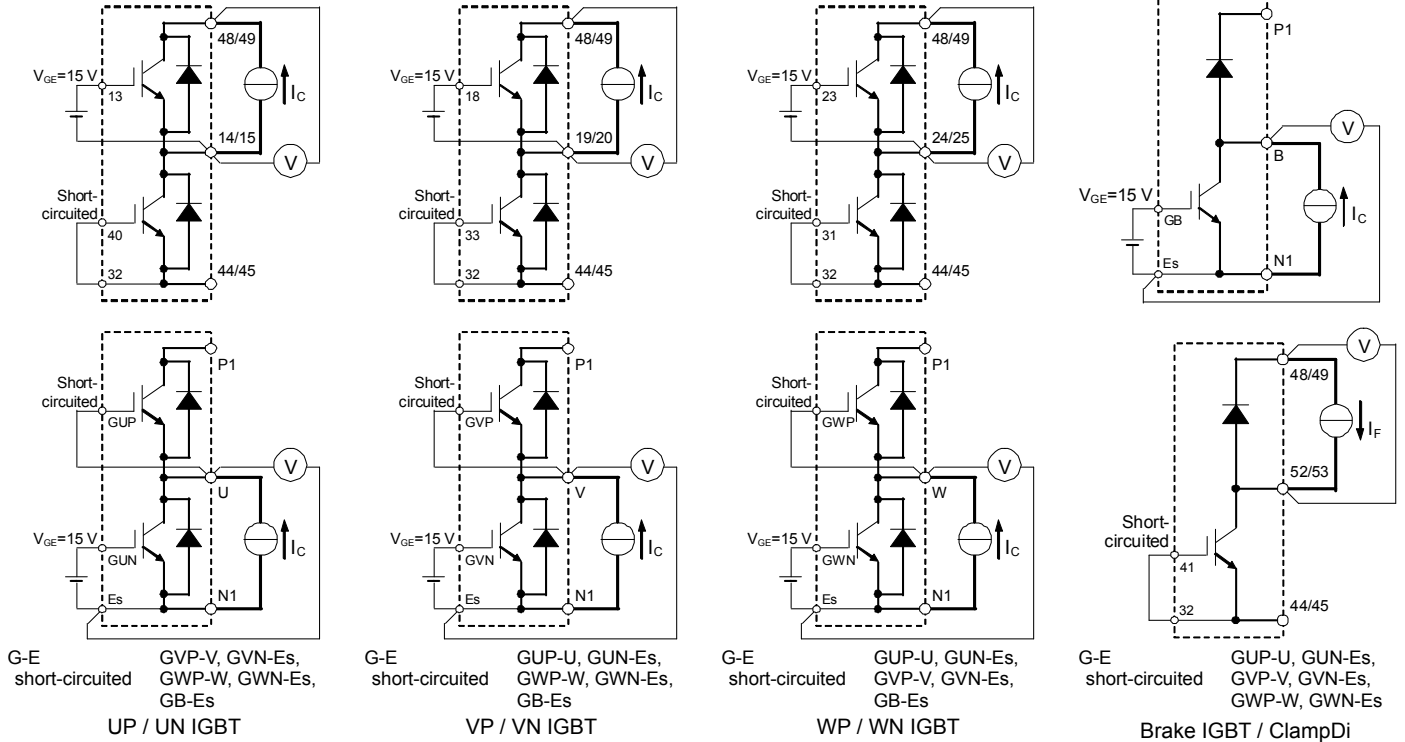

V_{CEsat} / ClampDi V_F test circuit

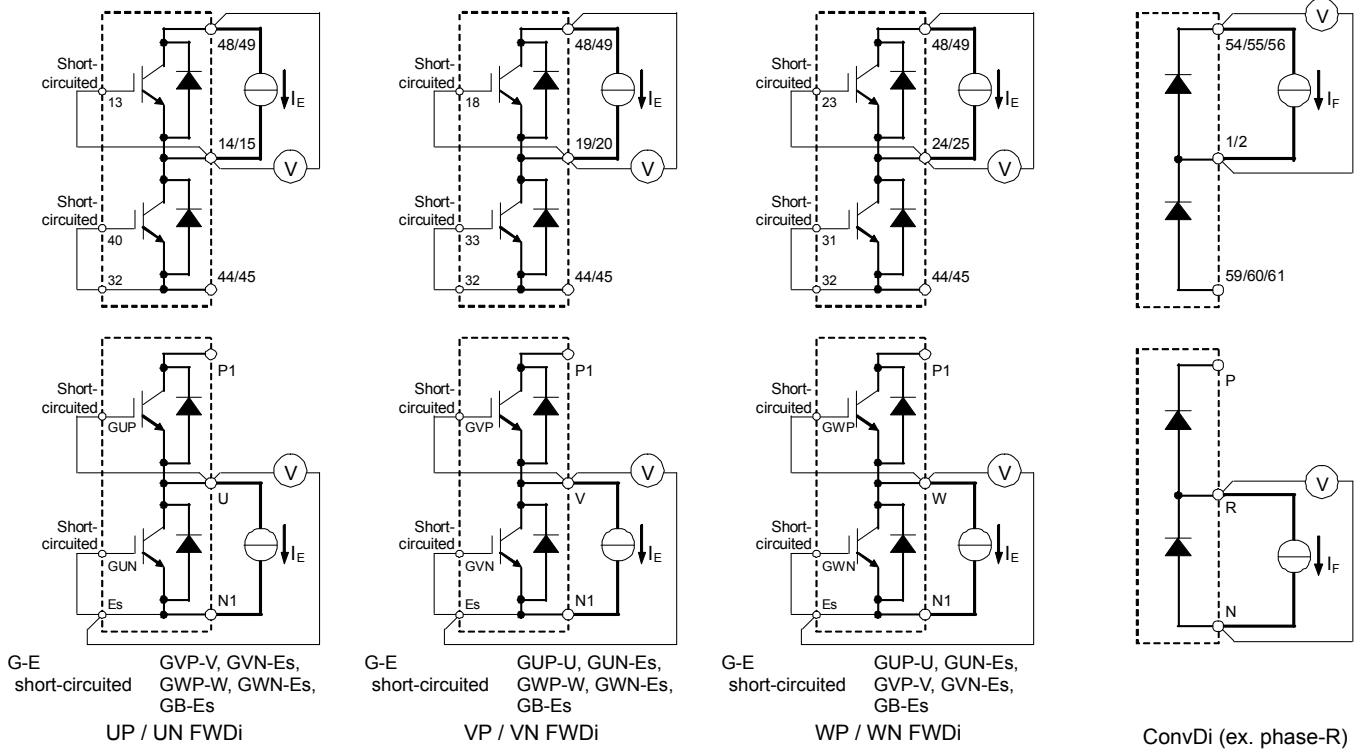

V_{EC} / ConvDi V_F test circuit

* In the above test circuit, should use all three main pin terminals (P1/N1/P/N/U/V/W) for connection with the terminals and the current source.

< IGBT MODULES >
CM100MXA-24S
 HIGH POWER SWITCHING USE
 INSULATED TYPE

PERFORMANCE CURVES

INVERTER PART

OUTPUT CHARACTERISTICS (TYPICAL)

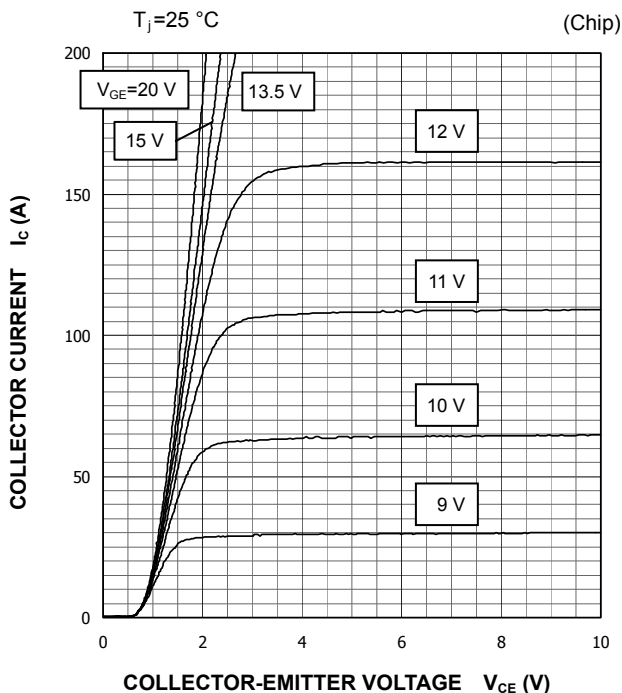

COLLECTOR-EMITTER SATURATION VOLTAGE CHARACTERISTICS (TYPICAL)

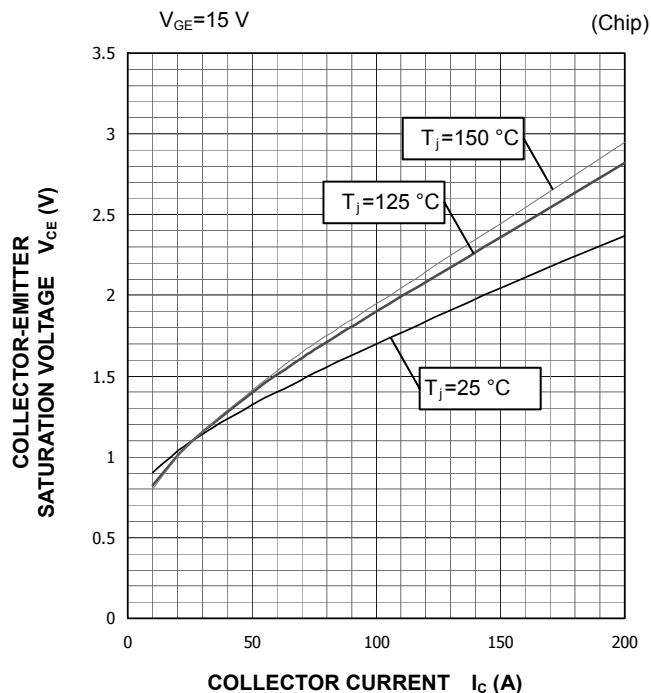

COLLECTOR-EMITTER SATURATION VOLTAGE CHARACTERISTICS (TYPICAL)

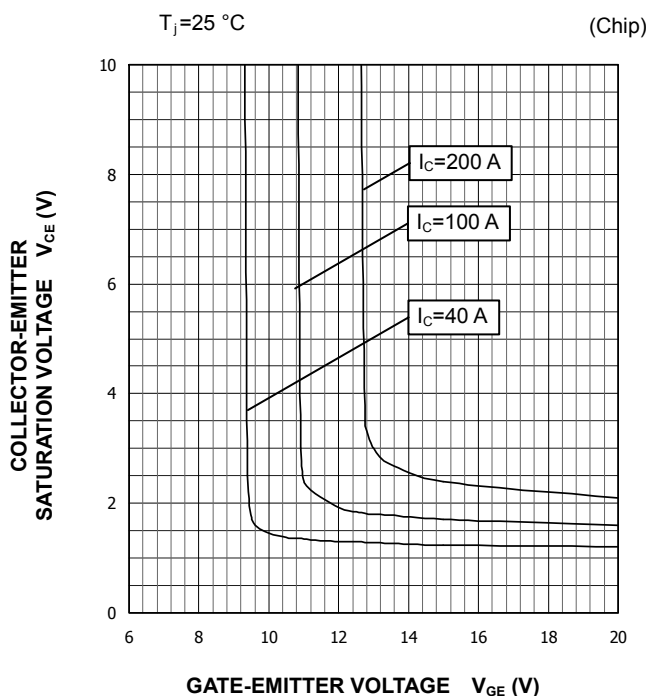

FREE WHEELING DIODE FORWARD CHARACTERISTICS (TYPICAL)

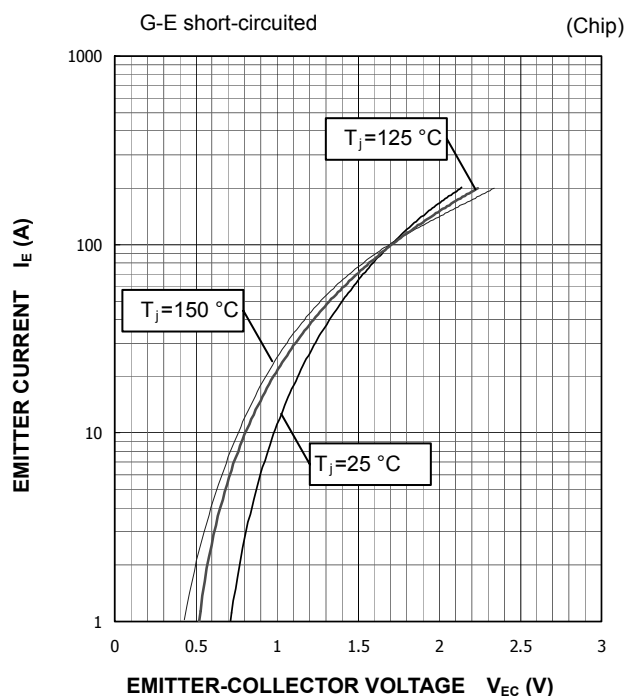

PERFORMANCE CURVES

INVERTER PART

HALF-BRIDGE
SWITCHING CHARACTERISTICS
(TYPICAL)

$V_{CC}=600\text{ V}$, $V_{GE}=\pm 15\text{ V}$, $R_G=6.2\ \Omega$, INDUCTIVE LOAD
——: $T_j=150\text{ }^\circ\text{C}$, - - - -: $T_j=125\text{ }^\circ\text{C}$

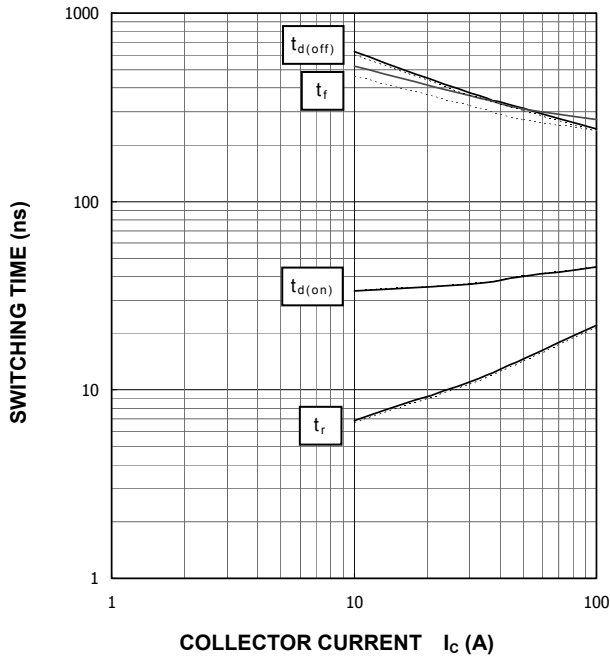

HALF-BRIDGE
SWITCHING CHARACTERISTICS
(TYPICAL)

$V_{CC}=600\text{ V}$, $V_{GE}=\pm 15\text{ V}$, $I_C=100\text{ A}$, INDUCTIVE LOAD
——: $T_j=150\text{ }^\circ\text{C}$, - - - -: $T_j=125\text{ }^\circ\text{C}$

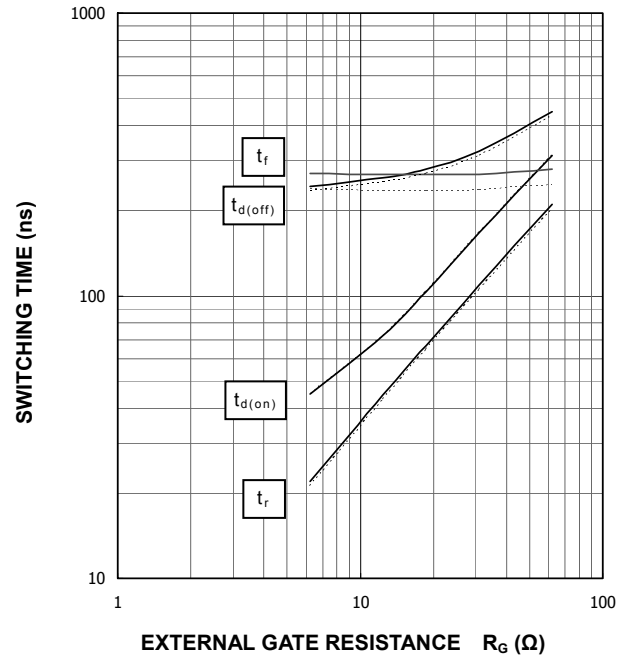

HALF-BRIDGE
SWITCHING CHARACTERISTICS
(TYPICAL)

$V_{CC}=600\text{ V}$, $V_{GE}=\pm 15\text{ V}$, $R_G=6.2\ \Omega$,
INDUCTIVE LOAD, PER PULSE
——: $T_j=150\text{ }^\circ\text{C}$, - - - -: $T_j=125\text{ }^\circ\text{C}$

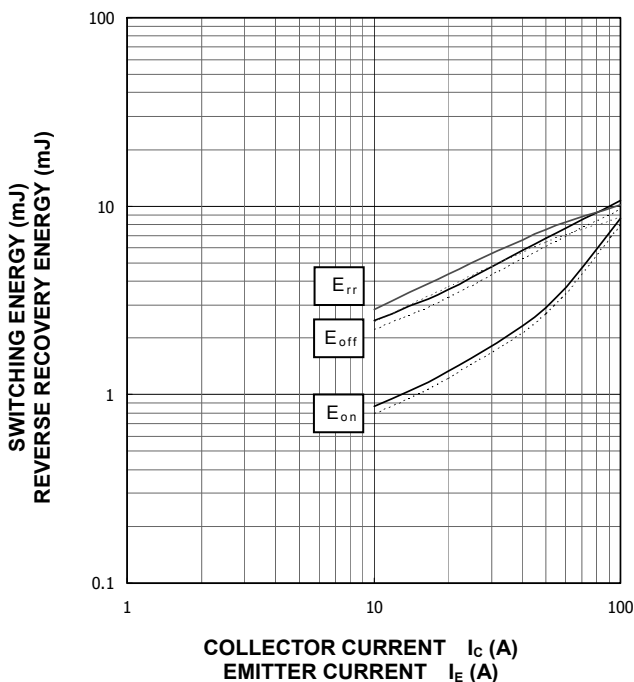

HALF-BRIDGE
SWITCHING CHARACTERISTICS
(TYPICAL)

$V_{CC}=600\text{ V}$, $V_{GE}=\pm 15\text{ V}$, $I_C=100\text{ A}$,
INDUCTIVE LOAD, PER PULSE
——: $T_j=150\text{ }^\circ\text{C}$, - - - -: $T_j=125\text{ }^\circ\text{C}$

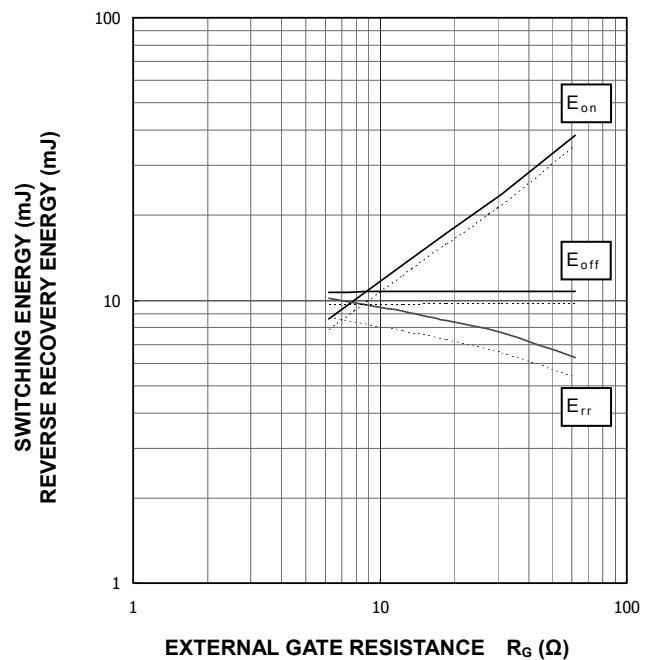

< IGBT MODULES >
CM100MXA-24S
 HIGH POWER SWITCHING USE
 INSULATED TYPE

PERFORMANCE CURVES

INVERTER PART

**CAPACITANCE CHARACTERISTICS
 (TYPICAL)**

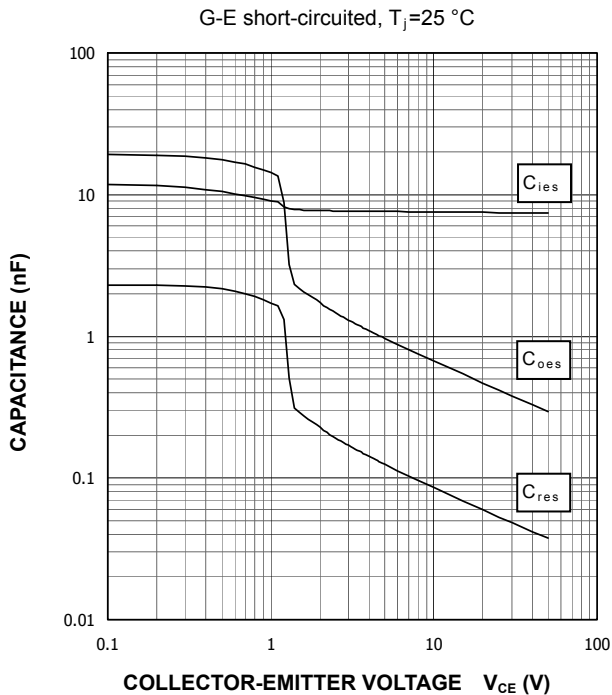

**FREE WHEELING DIODE
 REVERSE RECOVERY CHARACTERISTICS
 (TYPICAL)**

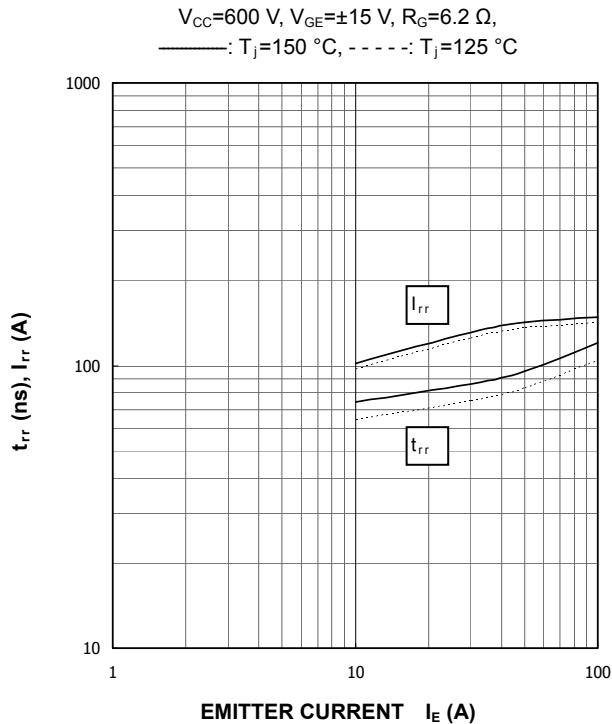

**GATE CHARGE CHARACTERISTICS
 (TYPICAL)**

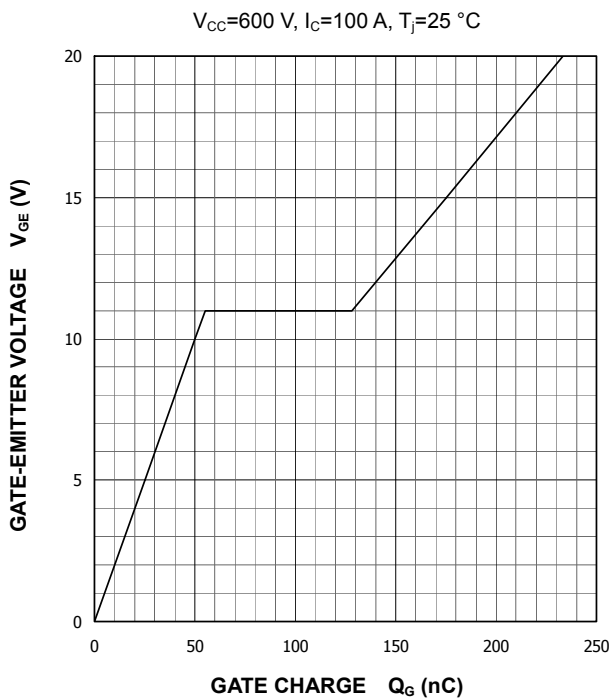

**TRANSIENT THERMAL IMPEDANCE CHARACTERISTICS
 (MAXIMUM)**

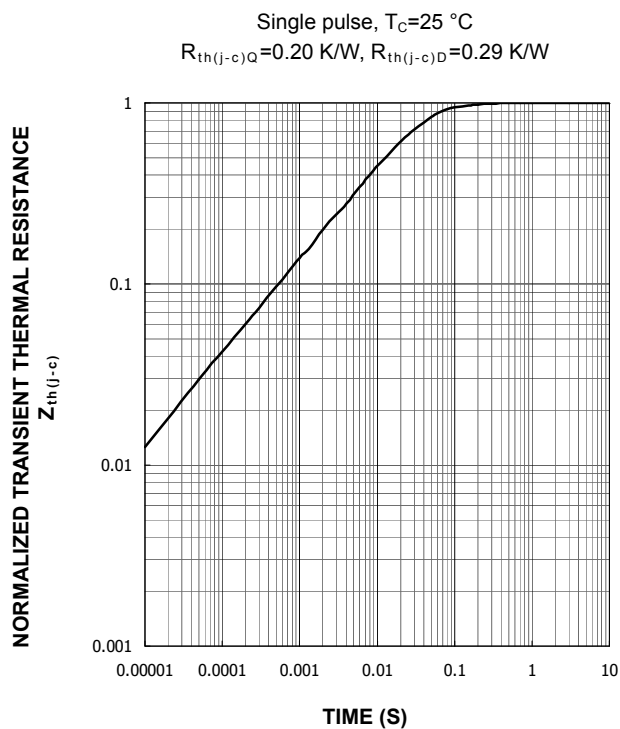

< IGBT MODULES >
CM100MXA-24S
 HIGH POWER SWITCHING USE
 INSULATED TYPE

PERFORMANCE CURVES

BRAKE PART

COLLECTOR-EMITTER SATURATION VOLTAGE CHARACTERISTICS (TYPICAL)

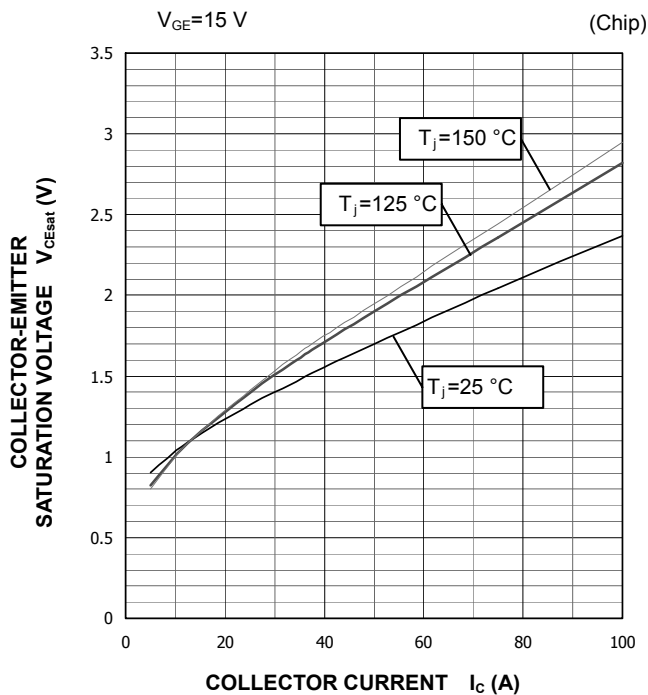

CLAMP DIODE FORWARD CHARACTERISTICS (TYPICAL)

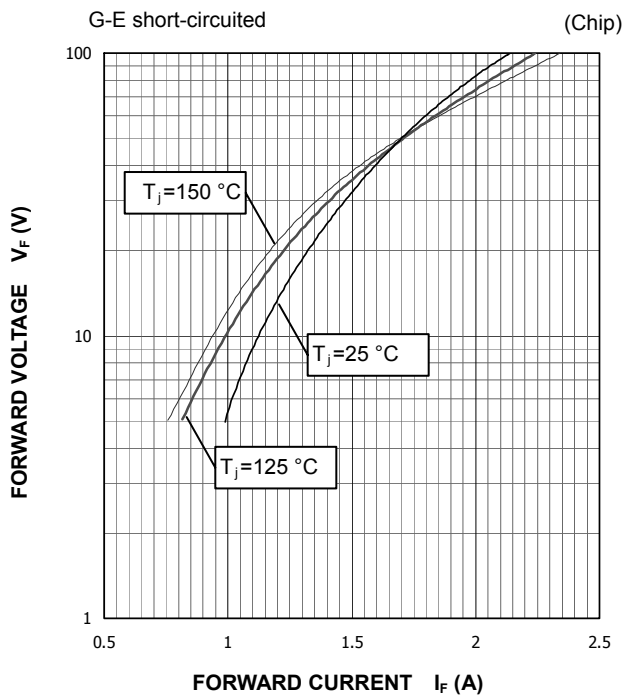

HALF-BRIDGE SWITCHING CHARACTERISTICS (TYPICAL)

$V_{CC}=600\text{ V}$, $V_{GE}=\pm 15\text{ V}$, $R_G=13\ \Omega$, INDUCTIVE LOAD
 —: $T_j=150\text{ }^\circ\text{C}$, - - - -: $T_j=125\text{ }^\circ\text{C}$

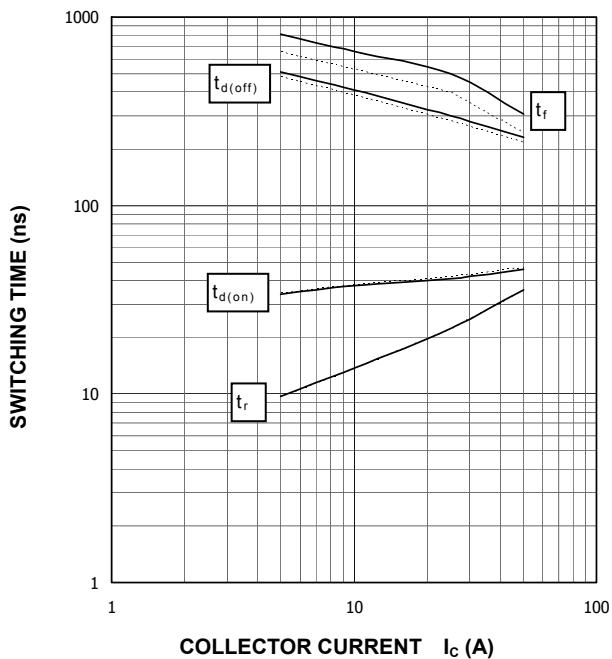

HALF-BRIDGE SWITCHING CHARACTERISTICS (TYPICAL)

$V_{CC}=600\text{ V}$, $I_C=50\text{ A}$, $V_{GE}=\pm 15\text{ V}$, INDUCTIVE LOAD
 —: $T_j=150\text{ }^\circ\text{C}$, - - - -: $T_j=125\text{ }^\circ\text{C}$

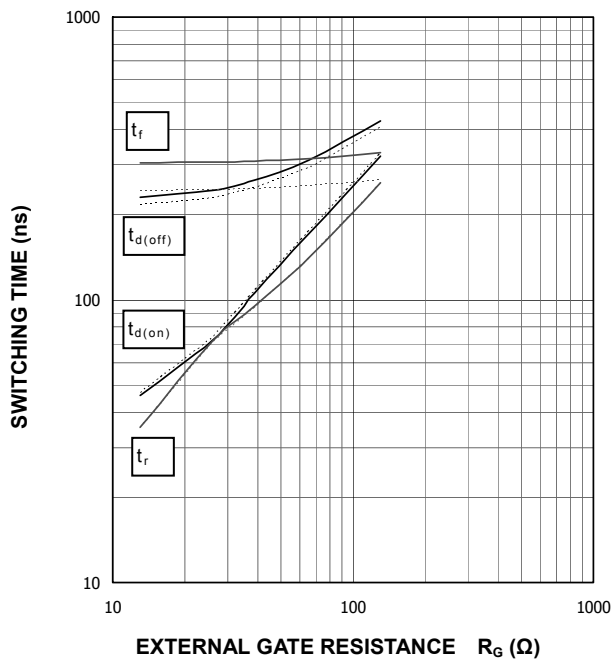

< IGBT MODULES >
CM100MXA-24S
 HIGH POWER SWITCHING USE
 INSULATED TYPE

PERFORMANCE CURVES

BRAKE PART

HALF-BRIDGE SWITCHING CHARACTERISTICS (TYPICAL)

$V_{CC}=600\text{ V}$, $V_{GE}=\pm 15\text{ V}$, $R_G=13\ \Omega$,
 INDUCTIVE LOAD, PER PULSE
 —: $T_j=150\text{ }^\circ\text{C}$, - - - -: $T_j=125\text{ }^\circ\text{C}$

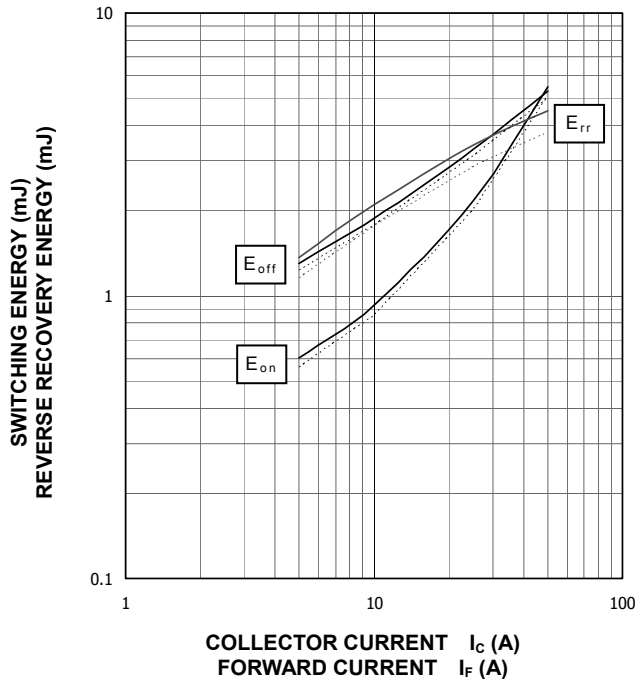

HALF-BRIDGE SWITCHING CHARACTERISTICS (TYPICAL)

$V_{CC}=600\text{ V}$, $I_C/I_F=50\text{ A}$, $V_{GE}=\pm 15\text{ V}$,
 INDUCTIVE LOAD, PER PULSE
 —: $T_j=150\text{ }^\circ\text{C}$, - - - -: $T_j=125\text{ }^\circ\text{C}$

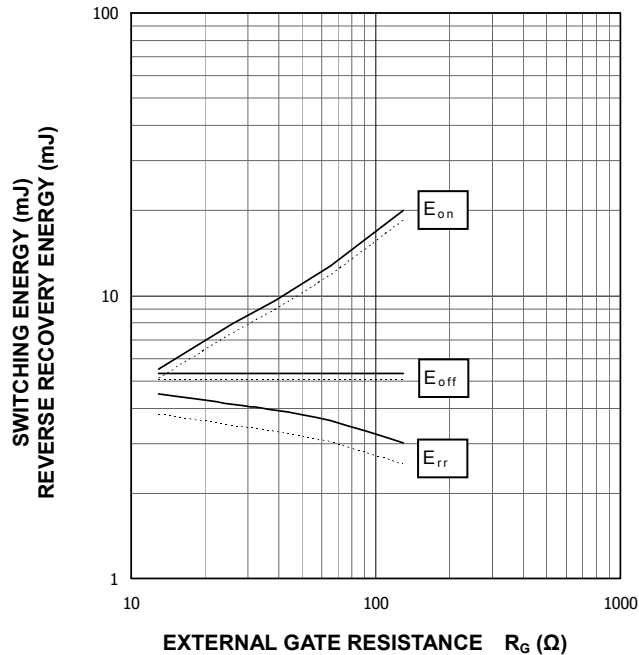

CLAMP DIODE REVERSE RECOVERY CHARACTERISTICS (TYPICAL)

$V_{CC}=600\text{ V}$, $V_{GE}=\pm 15\text{ V}$, $R_G=13\ \Omega$, INDUCTIVE LOAD
 —: $T_j=150\text{ }^\circ\text{C}$, - - - -: $T_j=125\text{ }^\circ\text{C}$

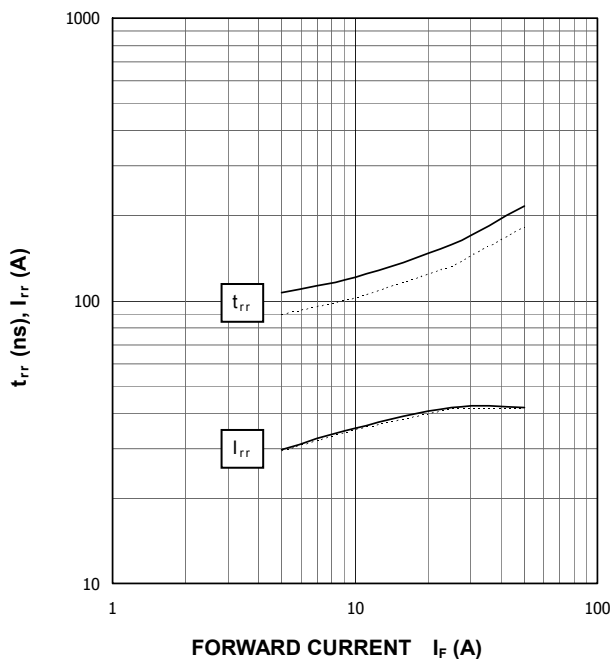

TRANSIENT THERMAL IMPEDANCE CHARACTERISTICS (MAXIMUM)

Single pulse, $T_C=25\text{ }^\circ\text{C}$
 $R_{th(j-c)Q}=0.35\text{ K/W}$, $R_{th(j-c)D}=0.63\text{ K/W}$

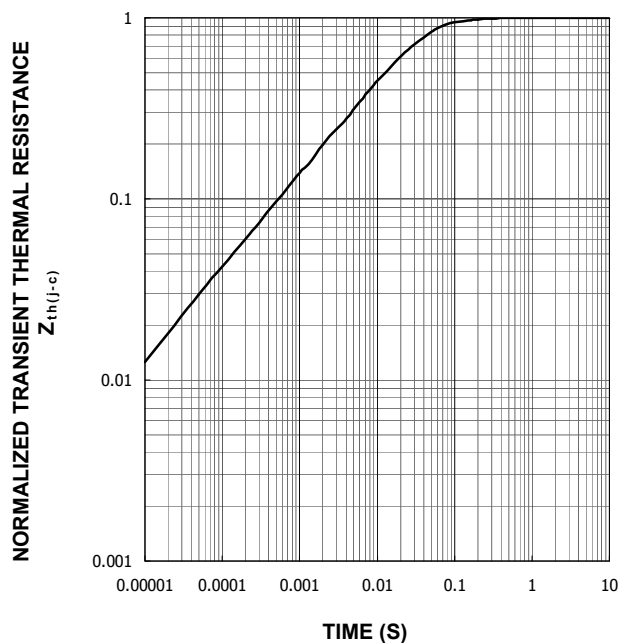

< IGBT MODULES >
CM100MXA-24S
 HIGH POWER SWITCHING USE
 INSULATED TYPE

PERFORMANCE CURVES

CONVERTER PART

**CONVERTER DIODE
 FORWARD CHARACTERISTICS
 (TYPICAL)**

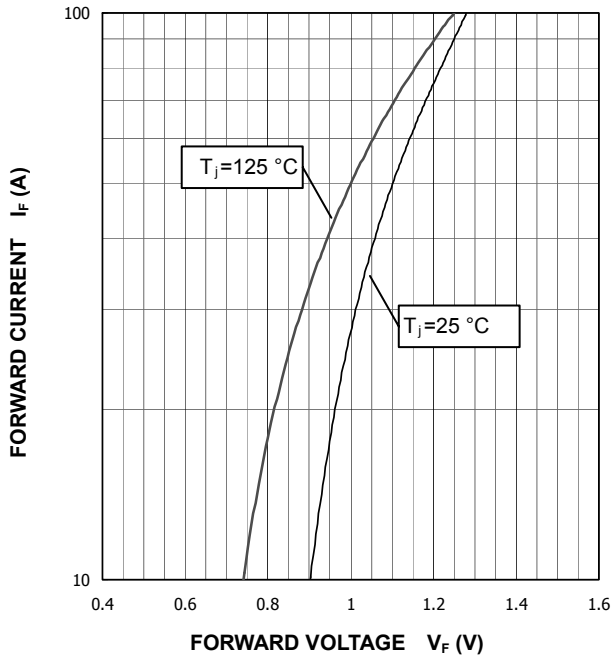

**TRANSIENT THERMAL IMPEDANCE CHARACTERISTICS
 (MAXIMUM)**

Single pulse, $T_c = 25\text{ °C}$
 $R_{th(j-c)D} = 0.24\text{ K/W}$

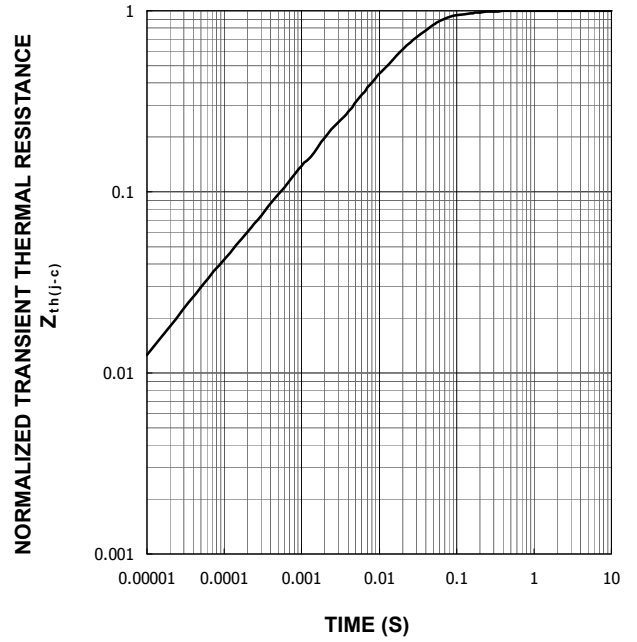

Keep safety first in your circuit designs!

Mitsubishi Electric Corporation puts the maximum effort into making semiconductor products better and more reliable, but there is always the possibility that trouble may occur with them. Trouble with semiconductors may lead to personal injury, fire or property damage. Remember to give due consideration to safety when making your circuit designs, with appropriate measures such as (i) placement of substitutive, auxiliary circuits, (ii) use of non-flammable material or (iii) prevention against any malfunction or mishap.

Notes regarding these materials

- These materials are intended as a reference to assist our customers in the selection of the Mitsubishi semiconductor product best suited to the customer's application; they do not convey any license under any intellectual property rights, or any other rights, belonging to Mitsubishi Electric Corporation or a third party.
- Mitsubishi Electric Corporation assumes no responsibility for any damage, or infringement of any third-party's rights, originating in the use of any product data, diagrams, charts, programs, algorithms, or circuit application examples contained in these materials.

•All information contained in these materials, including product data, diagrams, charts, programs and algorithms represents information on products at the time of publication of these materials, and are subject to change by Mitsubishi Electric Corporation without notice due to product improvements or other reasons. It is therefore recommended that customers contact Mitsubishi Electric Corporation or an authorized Mitsubishi Semiconductor product distributor for the latest product information before purchasing a product listed herein.

The information described here may contain technical inaccuracies or typographical errors. Mitsubishi Electric Corporation assumes no responsibility for any damage, liability, or other loss rising from these inaccuracies or errors.

Please also pay attention to information published by Mitsubishi Electric Corporation by various means, including the Mitsubishi Semiconductor home page (www.MitsubishiElectric.com/semiconductors/).

- When using any or all of the information contained in these materials, including product data, diagrams, charts, programs, and algorithms, please be sure to evaluate all information as a total system before making a final decision on the applicability of the information and products. Mitsubishi Electric Corporation assumes no responsibility for any damage, liability or other loss resulting from the information contained herein.
- Mitsubishi Electric Corporation semiconductors are not designed or manufactured for use in a device or system that is used under circumstances in which human life is potentially at stake. Please contact Mitsubishi Electric Corporation or an authorized Mitsubishi Semiconductor product distributor when considering the use of a product contained herein for any specific purposes, such as apparatus or systems for transportation, vehicular, medical, aerospace, nuclear, or undersea repeater use.
- The prior written approval of Mitsubishi Electric Corporation is necessary to reprint or reproduce in whole or in part these materials.
- If these products or technologies are subject to the Japanese export control restrictions, they must be exported under a license from the Japanese government and cannot be imported into a country other than the approved destination.
Any diversion or reexport contrary to the export control laws and regulations of Japan and/or the country of destination is prohibited.
- Please contact Mitsubishi Electric Corporation or an authorized Mitsubishi Semiconductor product distributor for further details on these materials or the products contained therein.