

MITSUBISHI IGBT MODULES  
**CM400DU-24NFH**

HIGH POWER SWITCHING USE

**CM400DU-24NFH**



- IC .....400A
- VCES ..... 1200V
- Insulated Type
- 2-elements in a pack

**APPLICATION**

High frequency switching use (30kHz to 60kHz).  
 Gradient amplifier, Induction heating, power supply, etc.

**OUTLINE DRAWING & CIRCUIT DIAGRAM**

Dimensions in mm

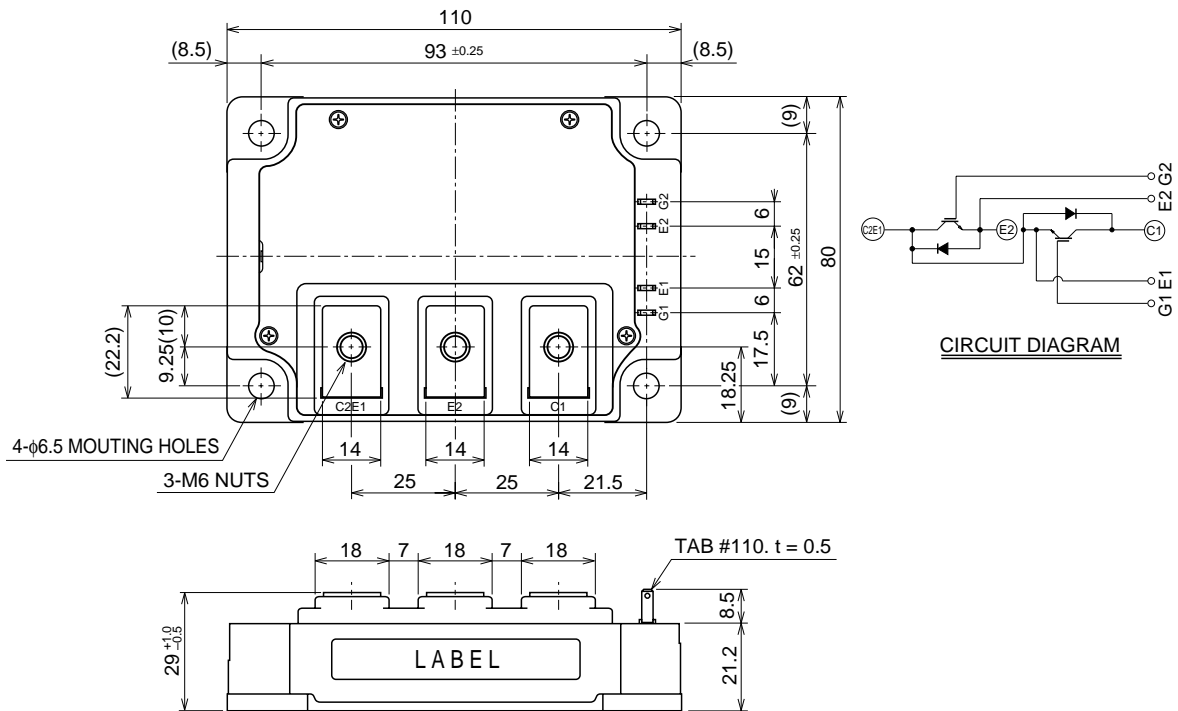

CM400DU-24NFH

HIGH POWER SWITCHING USE

MAXIMUM RATINGS (Tj = 25°C)

Symbol	Parameter	Conditions	Ratings	Unit
V <sub>CE</sub>	Collector-emitter voltage	G-E Short	1200	V
V <sub>GE</sub>	Gate-emitter voltage	C-E Short	±20	V
I <sub>C</sub>	Collector current	Operation (Note 2)	400	A
I <sub>CM</sub>		Pulse (Note 2)	800	A
I <sub>E</sub> (Note 1)	Emitter current	Operation (Note 2)	400	A
I <sub>EM</sub> (Note 1)		Pulse (Note 2)	800	A
P <sub>C</sub> (Note 3)	Maximum collector dissipation	T <sub>C</sub> = 25°C	1040	W
P <sub>C</sub> ' (Note 3)	Maximum collector dissipation	T <sub>C</sub> ' = 25°C <sup>4</sup>	2450	W
T <sub>j</sub>	Junction temperature		-40 ~ +150	°C
T <sub>stg</sub>	Storage temperature		-40 ~ +125	°C
V <sub>iso</sub>	Isolation voltage	Main Terminal to base plate, AC 1 min.	2500	V
—	Mounting torque	Main Terminal M6	3.5 ~ 4.5	N • m
—		Mounting holes M6	3.5 ~ 4.5	N • m
—	Weight	Typical value	580	g

ELECTRICAL CHARACTERISTICS (Tj = 25°C)

Symbol	Parameter	Test conditions	Limits			Unit
			Min.	Typ.	Max.	
I <sub>CES</sub>	Collector cutoff current	V <sub>CE</sub> = V <sub>CE</sub> , V <sub>GE</sub> = 0V	—	—	1	mA
V <sub>GE(th)</sub>	Gate-emitter threshold voltage	I <sub>C</sub> = 40mA, V <sub>CE</sub> = 10V	4.5	6	7.5	V
I <sub>GES</sub>	Gate leakage current	V <sub>GE</sub> = V <sub>GES</sub> , V <sub>CE</sub> = 0V	—	—	1.4	μA
V <sub>CE(sat)</sub>	Collector-emitter saturation voltage (Note 4)	I <sub>C</sub> = 400A, V <sub>GE</sub> = 15V	—	5.0	6.5	V
C <sub>ies</sub>	Input capacitance	V <sub>CE</sub> = 10V V <sub>GE</sub> = 0V	—	—	63	nF
C <sub>oes</sub>	Output capacitance		—	—	5.3	nF
C <sub>res</sub>	Reverse transfer capacitance		—	—	1.2	nF
Q <sub>G</sub>	Total gate charge	V <sub>CC</sub> = 600V, I <sub>C</sub> = 400A, V <sub>GE</sub> = 15V	—	1800	—	nC
t <sub>d(on)</sub>	Turn-on delay time	V <sub>CC</sub> = 600V, I <sub>C</sub> = 400A V <sub>GE1</sub> = V <sub>GE2</sub> = 15V R <sub>G</sub> = 0.78Ω, Inductive load switching operation I <sub>E</sub> = 400A	—	—	300	ns
t <sub>r</sub>	Turn-on rise time		—	—	100	ns
t <sub>d(off)</sub>	Turn-off delay time		—	—	500	ns
t <sub>f</sub>	Turn-off fall time		—	—	150	ns
t <sub>rr</sub> (Note 1)	Reverse recovery time		—	—	250	ns
Q <sub>rr</sub> (Note 1)	Reverse recovery charge		—	16	—	μC
V <sub>EC</sub> (Note 1)	Emitter-collector voltage	I <sub>E</sub> = 400A, V <sub>GE</sub> = 0V	—	—	3.5	V
R <sub>th(j-c)Q</sub>	Thermal resistance*1	IGBT part (1/2 module)	—	—	0.12	°C/W
R <sub>th(j-c)R</sub>		FWDi part (1/2 module)	—	—	0.23	°C/W
R <sub>th(c-f)</sub>	Contact thermal resistance	Case to fin, Thermal compound Applied*2 (1/2 module)	—	0.02	—	°C/W
R <sub>th(j-c')Q</sub>	Thermal resistance*4	IGBT part (1/2 module)	—	—	0.051 <sup>*3</sup>	°C/W
R <sub>th(j-c')R</sub>		FWDi part (1/2 module)	—	—	0.093 <sup>*3</sup>	°C/W
R <sub>G</sub>	External gate resistance		0.78	—	7.8	Ω

\*1 : T<sub>C</sub> measured point is shown in page OUTLINE DRAWING.

\*2 : Typical value is measured by using Shin-etsu Silicone "G-746".

\*3 : If you use this value, R<sub>th(f-a)</sub> should be measured just under the chips.

\*4 : T<sub>C</sub>' measured point is just under the chips.

Note 1. I<sub>E</sub>, V<sub>EC</sub>, t<sub>rr</sub> & Q<sub>rr</sub> represent characteristics of the anti-parallel, emitter to collector free-wheel diode (FWDi).

2. Pulse width and repetition rate should be such that the device junction temp. (T<sub>j</sub>) does not exceed T<sub>jmax</sub> rating.

3. Junction temperature (T<sub>j</sub>) should not increase beyond 150°C.

4. No short circuit capability is designed.

# CM400DU-24NFH

HIGH POWER SWITCHING USE

## PERFORMANCE CURVES

**OUTPUT CHARACTERISTICS (TYPICAL)**

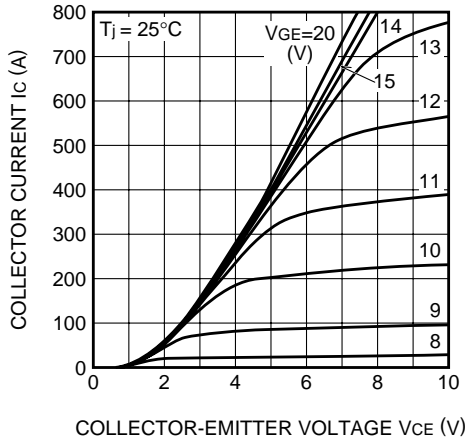

**TRANSFER CHARACTERISTICS (TYPICAL)**

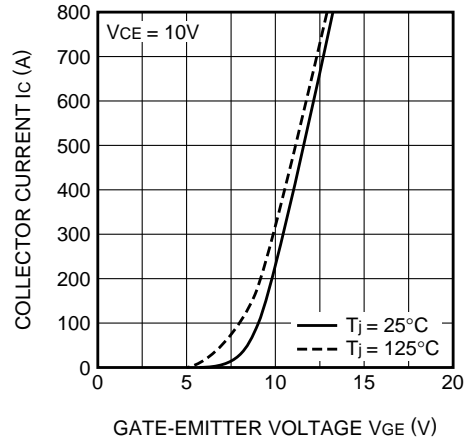

**COLLECTOR-EMITTER SATURATION VOLTAGE CHARACTERISTICS (TYPICAL)**

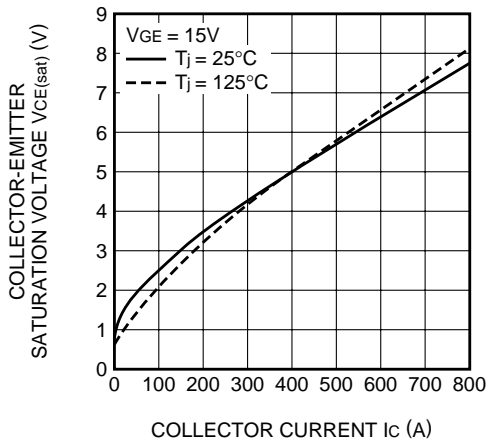

**COLLECTOR-EMITTER SATURATION VOLTAGE CHARACTERISTICS (TYPICAL)**

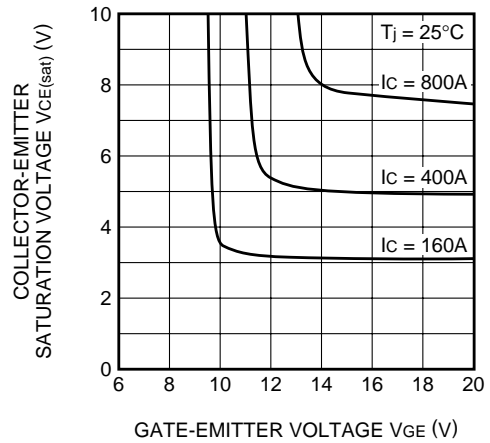

**FREE-WHEEL DIODE FORWARD CHARACTERISTICS (TYPICAL)**

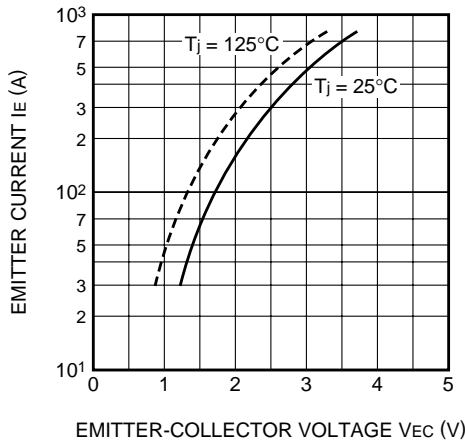

**CAPACITANCE CHARACTERISTICS (TYPICAL)**

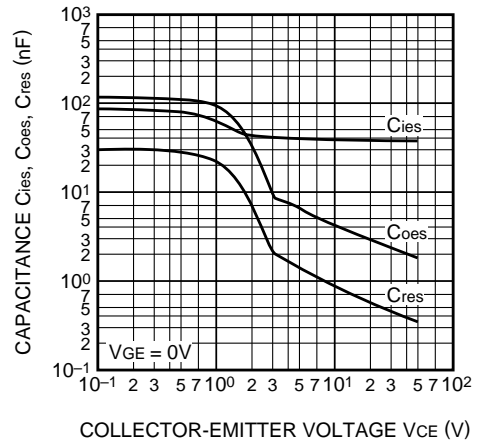

HALF-BRIDGE SWITCHING TIME CHARACTERISTICS (TYPICAL)

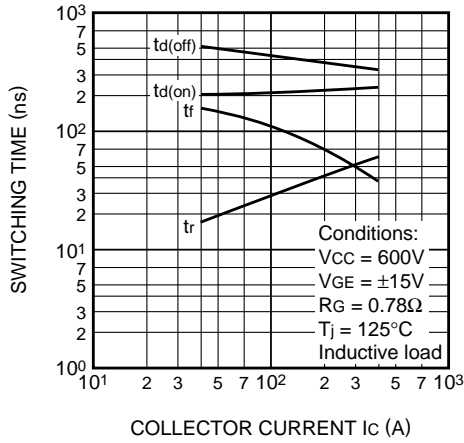

REVERSE RECOVERY CHARACTERISTICS OF FREE-WHEEL DIODE (TYPICAL)

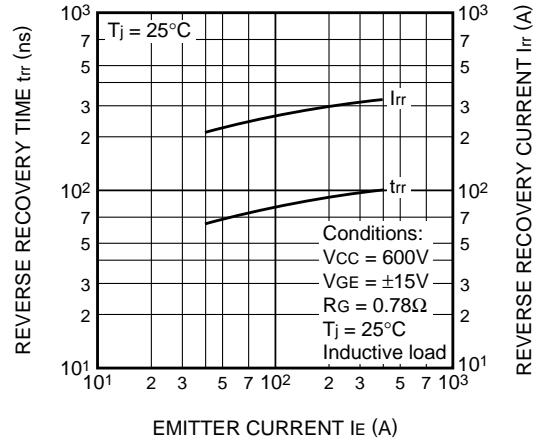

TRANSIENT THERMAL IMPEDANCE CHARACTERISTICS (IGBT part)

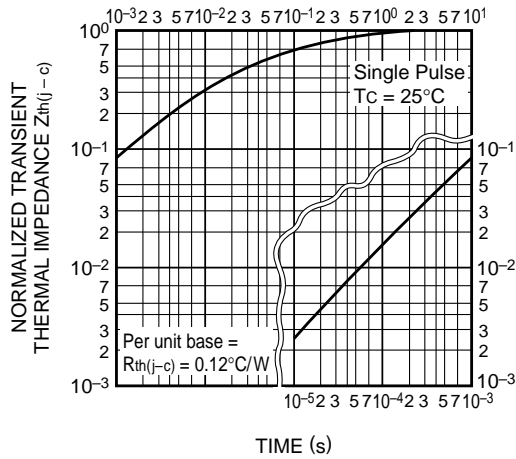

TRANSIENT THERMAL IMPEDANCE CHARACTERISTICS (FWDi part)

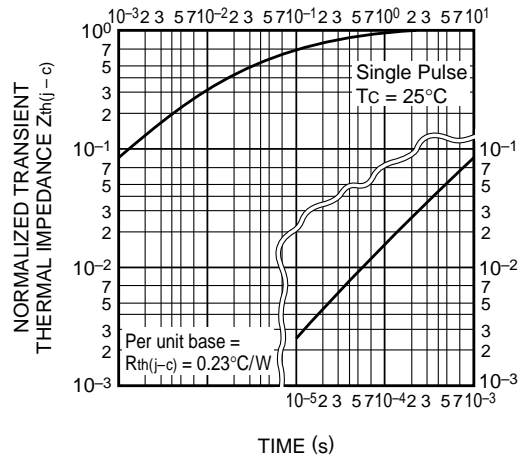

GATE CHARGE CHARACTERISTICS (TYPICAL)

