

SEMiX® 3s

Trench IGBT Modules

SEMiX653GB176HDs

Features

- Homogeneous Si
- Trench = Trenchgate technology
- $V_{CE(sat)}$ with positive temperature coefficient
- UL recognised file no. E63532

Typical Applications*

- AC inverter drives
- UPS
- Electronic welders

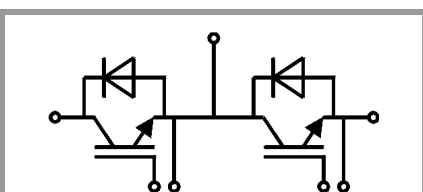
GB

Absolute Maximum Ratings				
Symbol	Conditions	Values	Unit	
IGBT				
V_{CES}		1700	V	
I_C	$T_j = 150\text{ °C}$	$T_c = 25\text{ °C}$	619	A
		$T_c = 80\text{ °C}$	438	A
I_{Cnom}		450	A	
I_{CRM}	$I_{CRM} = 2 \times I_{Cnom}$	900	A	
V_{GES}		-20 ... 20	V	
t_{psc}	$V_{CC} = 1000\text{ V}$	$T_j = 125\text{ °C}$	10	μs
	$V_{GE} \leq 20\text{ V}$			
	$V_{CES} \leq 1700\text{ V}$			
T_j		-55 ... 150	$^{\circ}\text{C}$	
Inverse diode				
I_F	$T_j = 150\text{ °C}$	$T_c = 25\text{ °C}$	545	A
		$T_c = 80\text{ °C}$	365	A
I_{Fnom}		450	A	
I_{FRM}	$I_{FRM} = 2 \times I_{Fnom}$	900	A	
I_{FSM}	$t_p = 10\text{ ms, sin } 180^{\circ}, T_j = 25\text{ °C}$	2900	A	
T_j		-40 ... 150	$^{\circ}\text{C}$	
Module				
$I_{t(RMS)}$		600	A	
T_{stg}		-40 ... 125	$^{\circ}\text{C}$	
V_{isol}	AC sinus 50Hz, t = 1 min	4000	V	

Characteristics					
Symbol	Conditions	min.	typ.	max.	Unit
IGBT					
$V_{CE(sat)}$	$I_C = 450\text{ A}$ $V_{GE} = 15\text{ V}$ chipelevel	$T_j = 25\text{ °C}$	2	2.45	V
		$T_j = 125\text{ °C}$	2.45	2.9	V
V_{CE0}		$T_j = 25\text{ °C}$	1	1.2	V
		$T_j = 125\text{ °C}$	0.9	1.1	V
r_{CE}	$V_{GE} = 15\text{ V}$	$T_j = 25\text{ °C}$	2.2	2.8	$\text{m}\Omega$
		$T_j = 125\text{ °C}$	3.4	4.0	$\text{m}\Omega$
$V_{GE(th)}$	$V_{GE} = V_{CE}, I_C = 18\text{ mA}$	5.2	5.8	6.4	V
I_{CES}	$V_{GE} = 0\text{ V}$ $V_{CE} = 1700\text{ V}$	$T_j = 25\text{ °C}$		3	mA
		$T_j = 125\text{ °C}$			mA
C_{ies}	$V_{CE} = 25\text{ V}$		39.6		nF
C_{oes}	$V_{GE} = 0\text{ V}$		1.65		nF
C_{res}			1.31		nF
Q_G	$V_{GE} = -8\text{ V...} + 15\text{ V}$		4200		nC
R_{Gint}	$T_j = 25\text{ °C}$		1.67		Ω
$t_{d(on)}$	$V_{CC} = 1200\text{ V}$	$T_j = 125\text{ °C}$	290		ns
t_r	$I_C = 450\text{ A}$	$T_j = 125\text{ °C}$	90		ns
		$T_j = 125\text{ °C}$	300		mJ
E_{on}	$R_{Gon} = 3.6\text{ }\Omega$	$T_j = 125\text{ °C}$	975		ns
$t_{d(off)}$	$R_{Goff} = 3.6\text{ }\Omega$	$T_j = 125\text{ °C}$	190		ns
t_f		$T_j = 125\text{ °C}$	180		mJ
E_{off}		$T_j = 125\text{ °C}$			
$R_{th(j-c)}$	per IGBT			0.054	K/W

SEMiX® 3s

Trench IGBT Modules

SEMiX653GB176HDs

Features

- Homogeneous Si
- Trench = Trenchgate technology
- $V_{CE(sat)}$ with positive temperature coefficient
- UL recognised file no. E63532

Typical Applications*

- AC inverter drives
- UPS
- Electronic welders

Characteristics						
Symbol	Conditions		min.	typ.	max.	Unit
Inverse diode						
$V_F = V_{EC}$	$I_F = 450\text{ A}$ $V_{GE} = 0\text{ V}$ chip	$T_j = 25\text{ °C}$		1.7	1.90	V
		$T_j = 125\text{ °C}$		1.7	1.9	V
V_{F0}		$T_j = 25\text{ °C}$	0.9	1.1	1.3	V
		$T_j = 125\text{ °C}$	0.7	0.9	1.1	V
r_F		$T_j = 25\text{ °C}$	1.3	1.3	1.3	mΩ
		$T_j = 125\text{ °C}$	1.8	1.8	1.8	mΩ
I_{RRM}	$I_F = 450\text{ A}$	$T_j = 125\text{ °C}$		380		A
Q_{rr}	$di/dt_{off} = 4200\text{ A}/\mu\text{s}$	$T_j = 125\text{ °C}$		130		μC
E_{rr}	$V_{GE} = -15\text{ V}$ $V_{CC} = 1200\text{ V}$	$T_j = 125\text{ °C}$		73		mJ
$R_{th(j-c)}$	per diode				0.11	K/W
Module						
L_{CE}				20		nH
$R_{CC'+EE'}$	res., terminal-chip	$T_C = 25\text{ °C}$		0.7		mΩ
		$T_C = 125\text{ °C}$		1		mΩ
$R_{th(c-s)}$	per module			0.04		K/W
M_s	to heat sink (M5)		3		5	Nm
M_t		to terminals (M6)	2.5		5	Nm
						Nm
w					300	g
Temperatur Sensor						
R_{100}	$T_c = 100\text{ °C}$ ($R_{25} = 5\text{ k}\Omega$)			$493 \pm 5\%$		Ω
$B_{100/125}$	$R_{(T)} = R_{100} \exp[B_{100/125}(1/T - 1/T_{100})]$; $T[\text{K}]$;			$3550 \pm 2\%$		K

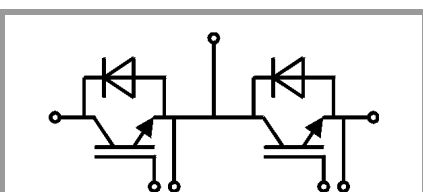
GB

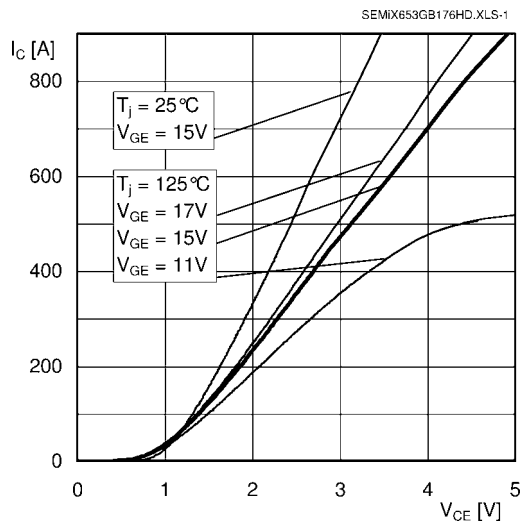

Fig. 1: Typ. output characteristic, inclusive $R_{CC'+EE}$

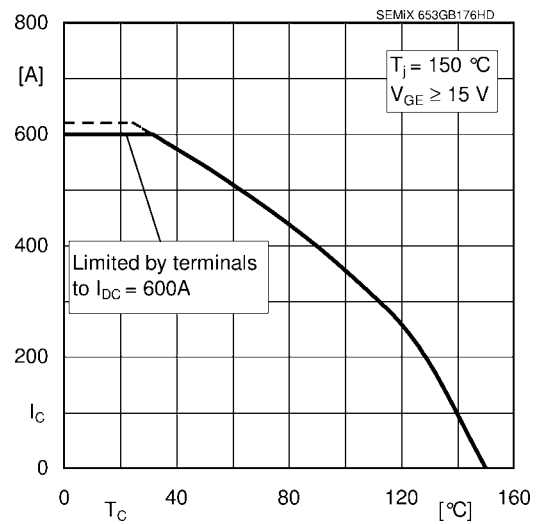

Fig. 2: Rated current vs. temperature $I_C = f(T_C)$

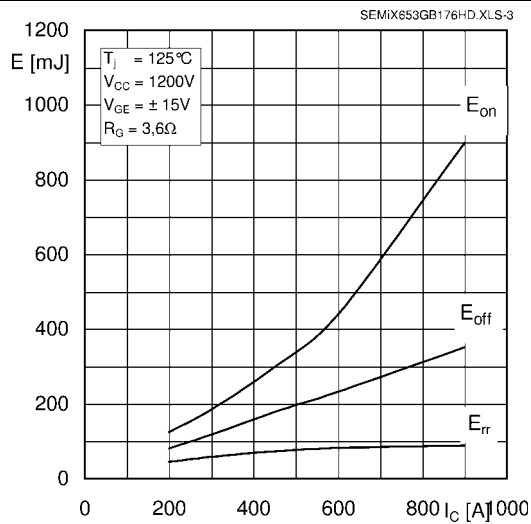

Fig. 3: Typ. turn-on /-off energy = $f(I_C)$

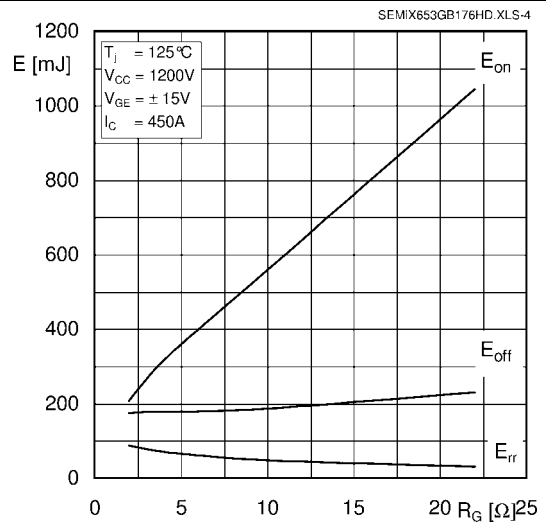

Fig. 4: Typ. turn-on /-off energy = $f(R_G)$

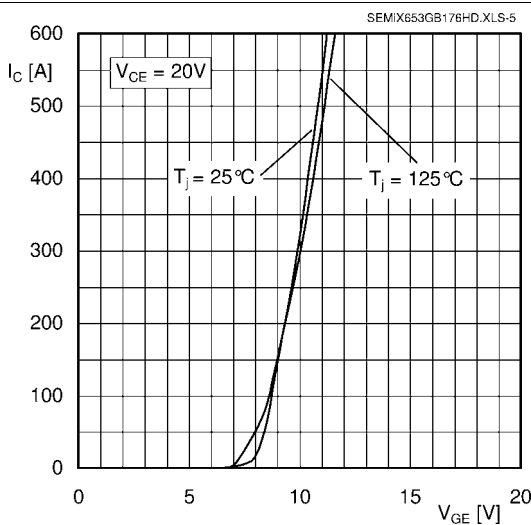

Fig. 5: Typ. transfer characteristic

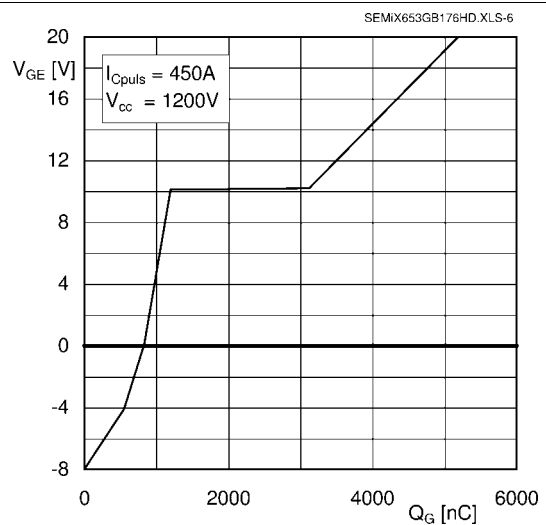

Fig. 6: Typ. gate charge characteristic

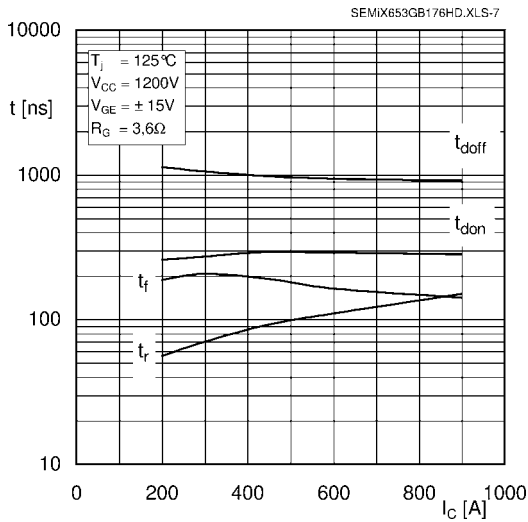

Fig. 7: Typ. switching times vs. I_C

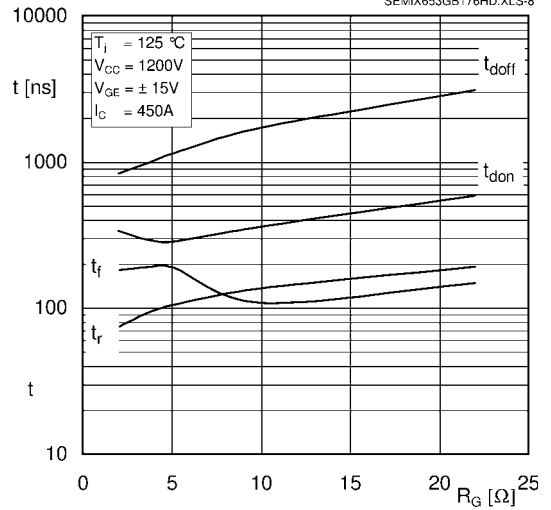

Fig. 8: Typ. switching times vs. gate resistor R_G

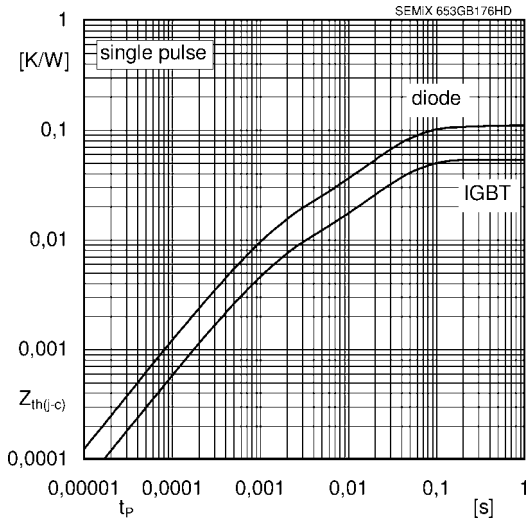

Fig. 9: Typ. transient thermal impedance

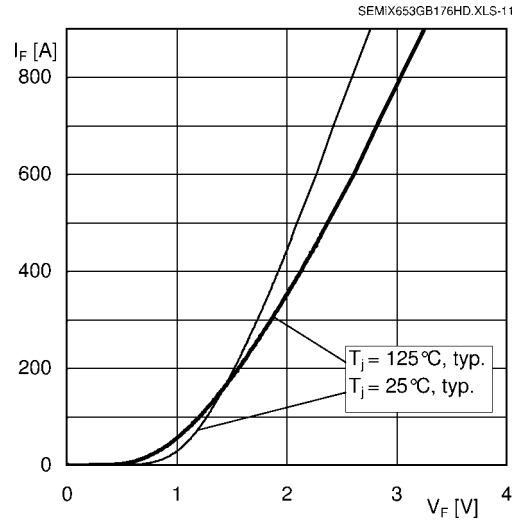

Fig. 10: Typ. CAL diode forward charact., incl. R_{CC+EE}

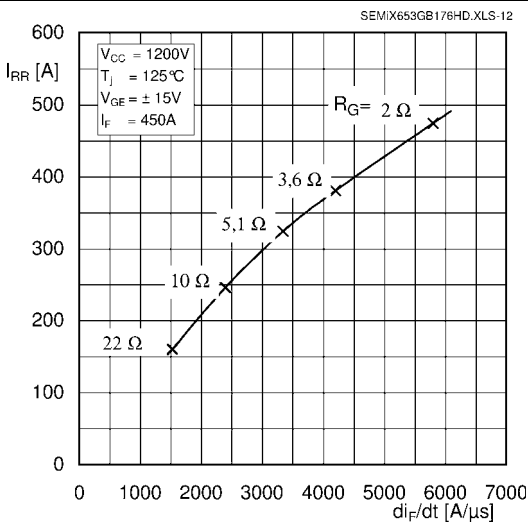

Fig. 11: Typ. CAL diode peak reverse recovery current

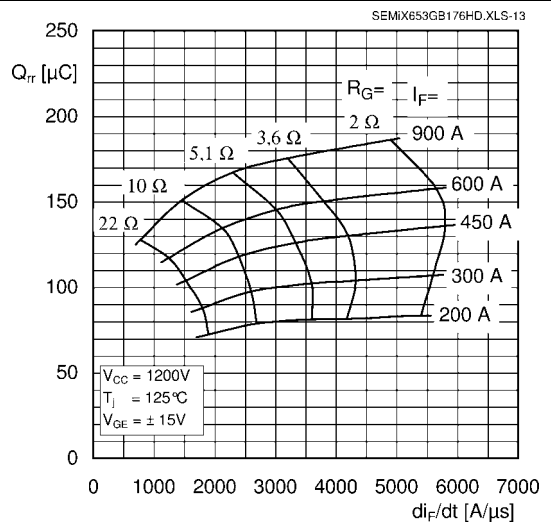
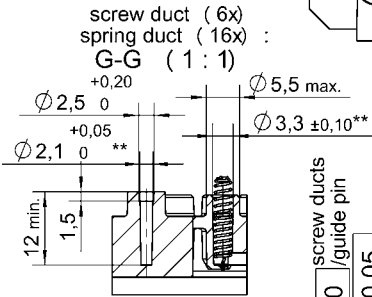
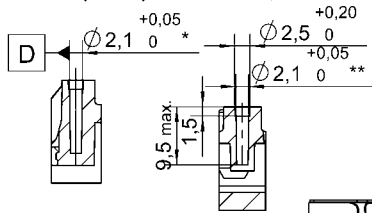

Fig. 12: Typ. CAL diode recovery charge

Case: SEMiX 3s

screw duct (left top) : F-F (1:1)
 screw duct (1x centre) : H-H (1:1)



\square	0,3	connector 1-2 / 3-4
\parallel	0,2	each connector A

general tolerance:
 ISO 2768-mK
 ISO 8015

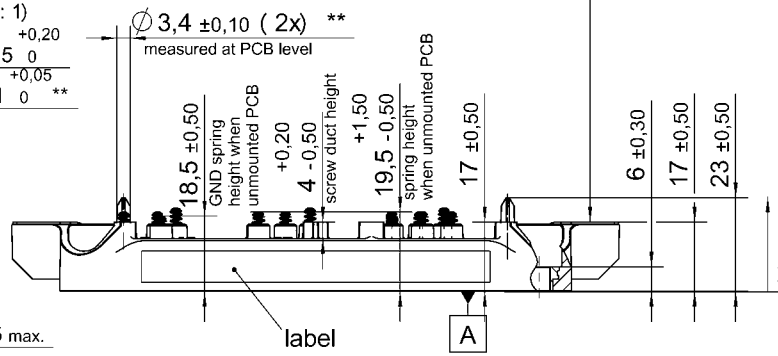

All measures in Z-direction valid when mounted to heat sink

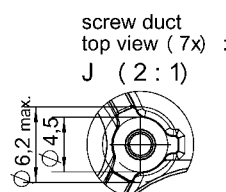
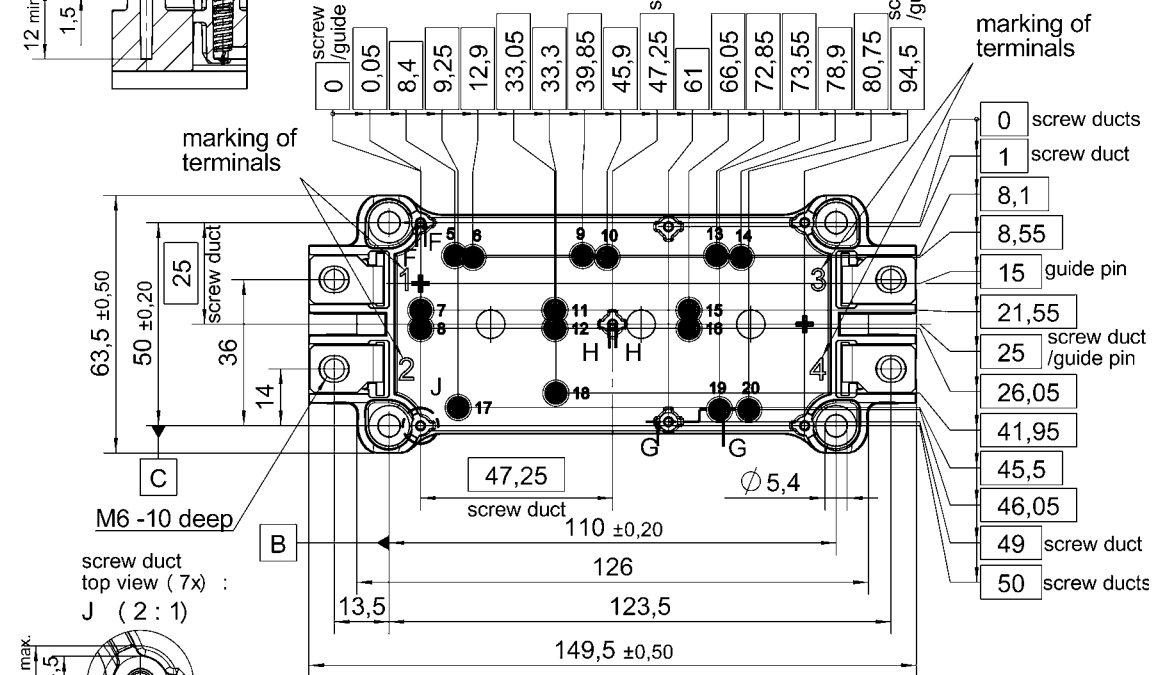

*screw duct left / top with	ϕ	ϕ 0,2	A	B	C	Rules for the contact PCB: - holes guidepins = ϕ 4 ± 0,1 / position tolerance ± 0,1 - holes for screws = ϕ 2,9 ± 0,1 / position tolerance ± 0,1 - spring contact pad = ϕ 3,6 ± 0,1 / position tolerance ± 0,1
**screw ducts / guide pins / spring ducts with	ϕ	ϕ 0,2	A	D	C	

SEMiX 3s

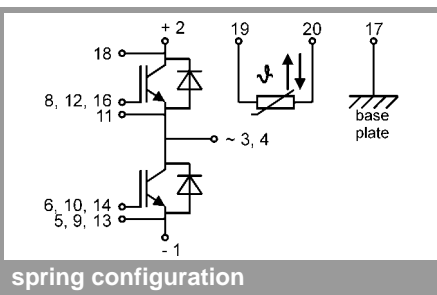

spring configuration

This is an electrostatic discharge sensitive device (ESDS), international standard IEC 60747-1, Chapter IX

* The specifications of our components may not be considered as an assurance of component characteristics. Components have to be tested for the respective application. Adjustments may be necessary. The use of SEMIKRON products in life support appliances and systems is subject to prior specification and written approval by SEMIKRON. We therefore strongly recommend prior consultation of our personal.