

SEMITOP® 1

IGBT Module

SK25GB065

Preliminary Data

Features

- Compact design
- One screw mounting
- Heat transfer and isolation through direct copper bonded aluminium oxide ceramic (DCB)
- N-channel homogeneous silicon structure (NPT-Non punch-through IGBT)
- High short circuit capability
- Low tail current with low temperature dependence
- UL recognized, file no. E63 532

Typical Applications*

- Switching (not for linear use)
- Driver
- Switched mode power supplies
- UPS
- High switching applications (typ. >=15kHz)

GB

Absolute Maximum Ratings		$T_s = 25\text{ }^\circ\text{C}$, unless otherwise specified	
Symbol	Conditions	Values	Units
IGBT			
V_{CES}	$T_j = 25\text{ }^\circ\text{C}$	600	V
I_C	$T_j = 125\text{ }^\circ\text{C}$	$T_s = 25\text{ }^\circ\text{C}$	30 A
		$T_s = 80\text{ }^\circ\text{C}$	21 A
I_{CRM}	$I_{CRM} = 2 \times I_{Cnom}$	60	A
V_{GES}		± 20	V
t_{psc}	$V_{CC} = 300\text{ V}; V_{GE} \leq 20\text{ V}; T_j = 125\text{ }^\circ\text{C}$ $V_{CES} < 600\text{ V}$	10	μs
Inverse Diode			
I_F	$T_j = 150\text{ }^\circ\text{C}$	$T_s = 25\text{ }^\circ\text{C}$	36 A
		$T_s = 80\text{ }^\circ\text{C}$	24 A
I_{FRM}	$I_{FRM} = 2 \times I_{Fnom}$	70	A
I_{FSM}	$t_p = 10\text{ ms}; \text{half sine wave } T_j = 150\text{ }^\circ\text{C}$	200	A
Module			
$I_{t(RMS)}$			A
T_{vj}		-40 ... +150	$^\circ\text{C}$
T_{stg}		-40 ... +125	$^\circ\text{C}$
V_{isol}	AC, 1 min.	2500	V

Characteristics		$T_s = 25\text{ }^\circ\text{C}$, unless otherwise specified			
Symbol	Conditions	min.	typ.	max.	Units
IGBT					
$V_{GE(th)}$	$V_{GE} = V_{CE}, I_C = 0,7\text{ mA}$	3	4	5	V
I_{CES}	$V_{GE} = 0\text{ V}, V_{CE} = V_{CES}$	$T_j = 25\text{ }^\circ\text{C}$		0,1	mA
		$T_j = 125\text{ }^\circ\text{C}$			mA
I_{GES}	$V_{CE} = 0\text{ V}, V_{GE} = 20\text{ V}$	$T_j = 25\text{ }^\circ\text{C}$		120	nA
		$T_j = 125\text{ }^\circ\text{C}$			nA
V_{CE0}		$T_j = 25\text{ }^\circ\text{C}$	1,2	1,3	V
		$T_j = 125\text{ }^\circ\text{C}$	1,1	0,9	V
r_{CE}	$V_{GE} = 15\text{ V}$	$T_j = 25\text{ }^\circ\text{C}$	20	23	$\text{m}\Omega$
		$T_j = 125\text{ }^\circ\text{C}$	33	43	$\text{m}\Omega$
$V_{CE(sat)}$	$I_{Cnom} = 30\text{ A}, V_{GE} = 15\text{ V}$	$T_j = 25\text{ }^\circ\text{C}_{chiplev.}$	1,8	2	V
		$T_j = 125\text{ }^\circ\text{C}_{chiplev.}$	2,1	2,2	V
C_{ies}	$V_{CE} = 25, V_{GE} = 0\text{ V}$	$f = 1\text{ MHz}$	1,6		nF
C_{oes}			0,15		nF
C_{res}			0,092		nF
$t_{d(on)}$	$R_{Gon} = 33\text{ }\Omega$	$V_{CC} = 300\text{ V}$ $I_C = 25\text{ A}$	30		ns
t_r			35		ns
E_{on}			0,75		mJ
$t_{d(off)}$	$R_{Goff} = 33\text{ }\Omega$	$T_j = 125\text{ }^\circ\text{C}$ $V_{GE} = \pm 15\text{ V}$	250		ns
t_f			15		ns
E_{off}			0,6		mJ
$R_{th(j-s)}$	per IGBT			1,4	K/W

SEMITOP® 1

IGBT Module

SK25GB065

Preliminary Data

Features

- Compact design
- One screw mounting
- Heat transfer and isolation through direct copper bonded aluminium oxide ceramic (DCB)
- N-channel homogeneous silicon structure (NPT-Non punch-through IGBT)
- High short circuit capability
- Low tail current with low temperature dependence
- UL recognized, file no. E63 532

Typical Applications*

- Switching (not for linear use)
- Driver
- Switched mode power supplies
- UPS
- High switching applications (typ. >=15kHz)

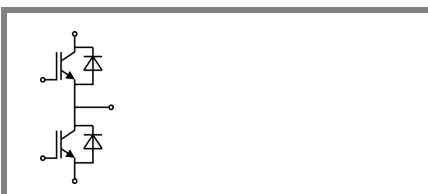

GB

Characteristics

Symbol	Conditions	min.	typ.	max.	Units
Inverse Diode					
$V_F = V_{EC}$	$I_{Fnom} = 25 \text{ A}; V_{GE} = 0 \text{ V}$	$T_j = 25 \text{ }^\circ\text{C}_{chiplev.}$	1,45	1,7	V
		$T_j = 125 \text{ }^\circ\text{C}_{chiplev.}$	1,4	1,75	V
V_{F0}			0,85	0,9	V
r_F			22	32	mΩ
I_{RRM}	$I_F = 25 \text{ A}$		16		A
Q_{rr}	$di/dt = -500 \text{ A}/\mu\text{s}$		2		μC
E_{rr}	$V_{CC} = 300\text{V}$		0,25		mJ
$R_{th(j-s)D}$	per diode			1,7	K/W
M_s	to heat sink			1,5	Nm
w			13		g

This is an electrostatic discharge sensitive device (ESDS), international standard IEC 60747-1, Chapter IX.

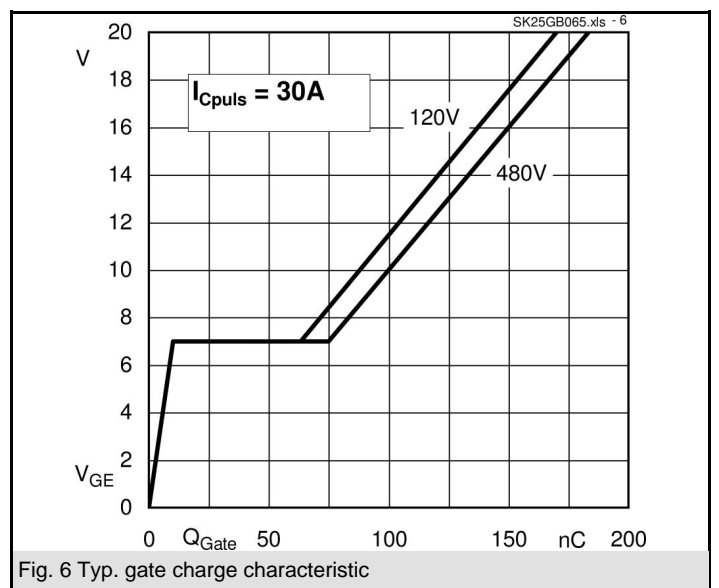
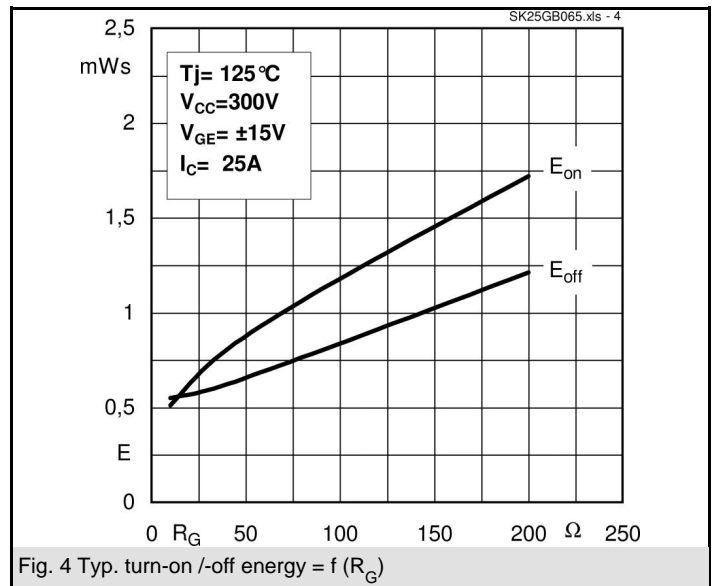
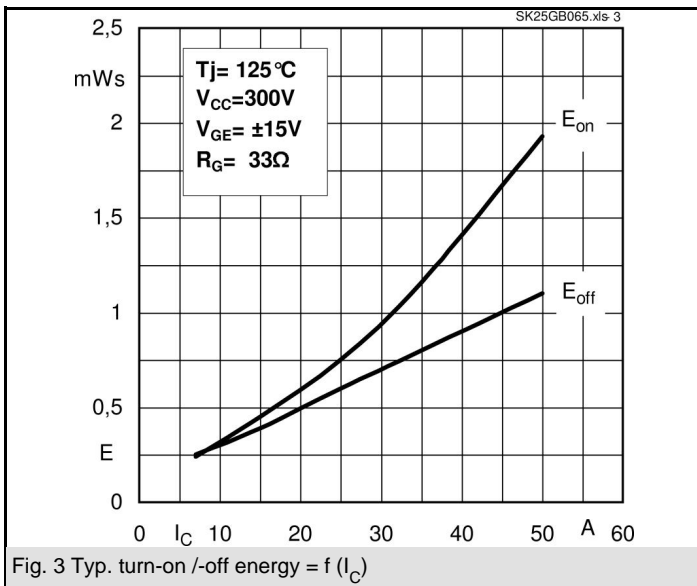
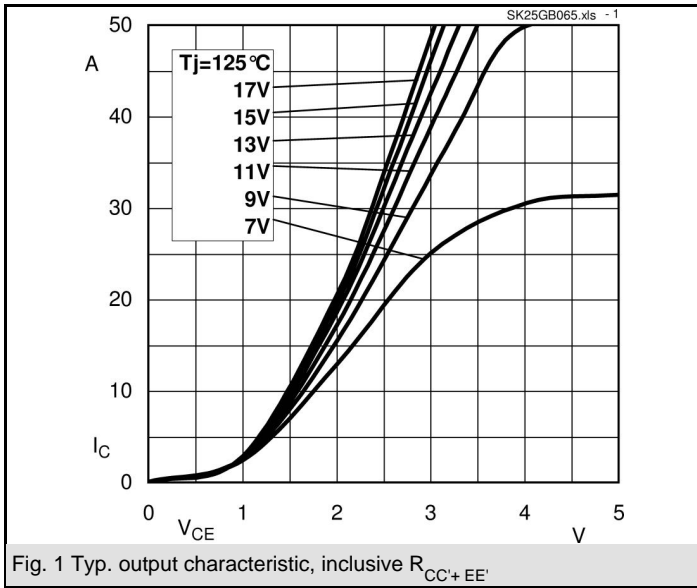
* The specifications of our components may not be considered as an assurance of component characteristics. Components have to be tested for the respective application. Adjustments may be necessary. The use of SEMIKRON products in life support appliances and systems is subject to prior specification and written approval by SEMIKRON. We therefore strongly recommend prior consultation of our personal.



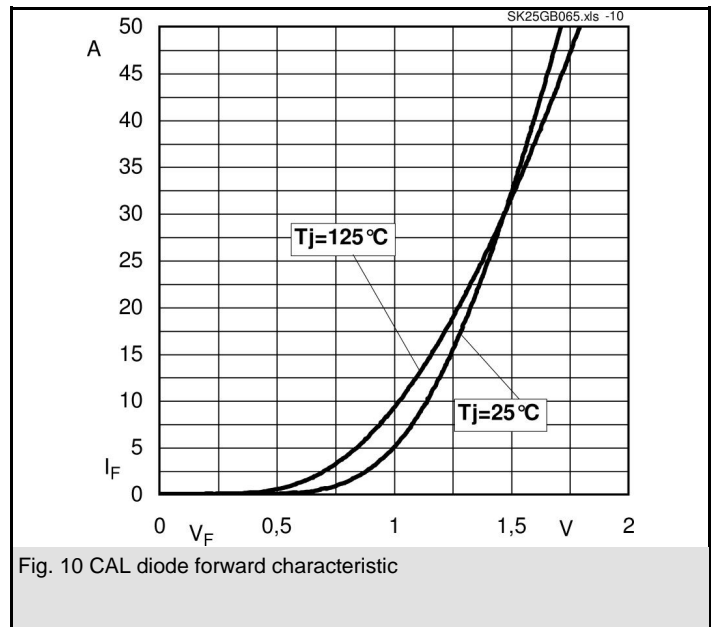
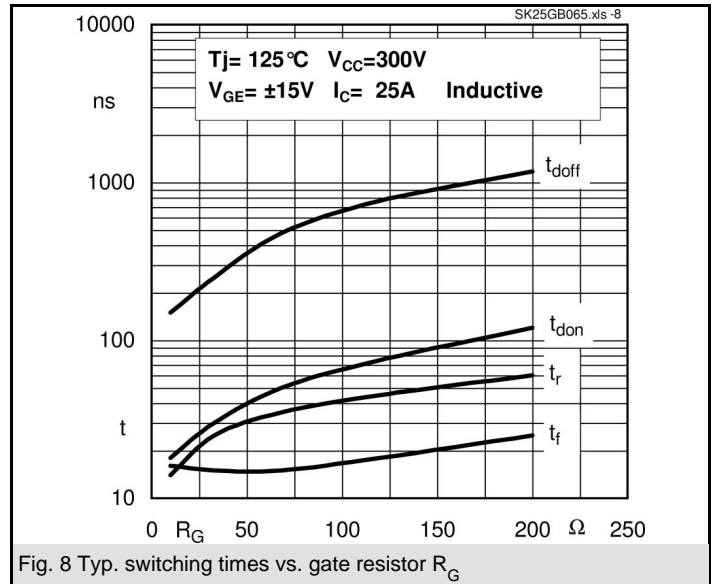
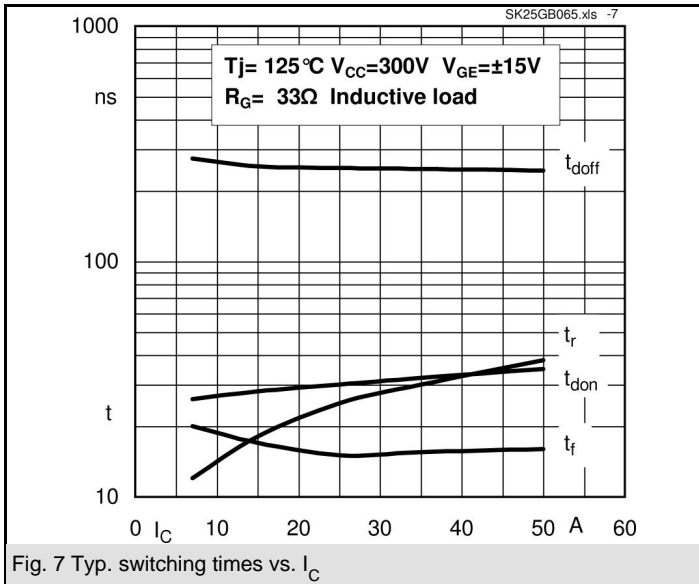

UL recognized file

no. E 63 532

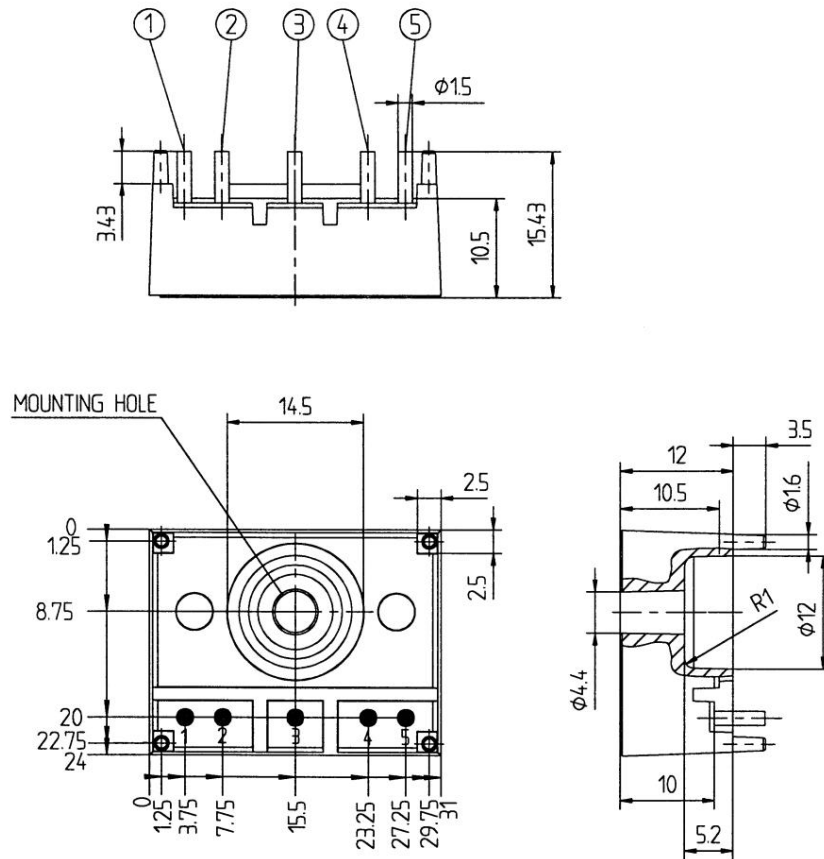

Case T3 (Suggested hole diameter, in the PCB, for solder pins and plastic mounting pins: 2mm)

