

# SKM 200GB125D



**SEMITRANS® 3**

## Ultra Fast IGBT Modules

**SKM 200GB125D**

**SKM 200GAL125D**

**SKM 200GAR125D**

### Features

- N channel , homogeneous Si
- Low inductance case
- Short tail current with low temperature dependence
- High short circuit capability, self limiting to  $6 \times I_{Cnom}$
- Fast & soft inverse CAL diodes
- Isolated copper baseplate using DCB Direct Copper Bonding Technology
- Large clearance (13 mm) and creepage distance (20 mm)

### Typical Applications\*

- Switched mode power supplies at  $f_{sw} > 20$  kHz
- Resonant inverters up to 100 kHz
- Inductive heating
- Electronic welders at  $f_{sw} > 20$  kHz

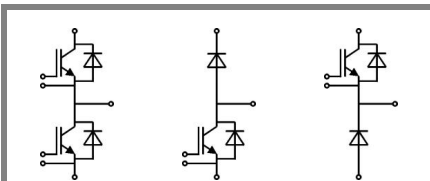

GB

GAL

GAR

| Absolute Maximum Ratings  |  | $T_c = 25^\circ\text{C}$ , unless otherwise specified |      |                  |   |
|---------------------------|--|---|------|------------------|---|
| Symbol                    | Conditions   | Values  |      | Units            |   |
| <b>IGBT</b>               |  |   |      |                  |   |
| $V_{CES}$                 | $T_j = 25^\circ\text{C}$   | 1200  |      | V                |   |
| $I_C$                     | $T_j = 150^\circ\text{C}$  | $T_{case} = 25^\circ\text{C}$                         | 200  |                  | A |
|                           |  | $T_{case} = 80^\circ\text{C}$                         | 160  |                  | A |
| $I_{CRM}$                 | $I_{CRM} = 2 \times I_{Cnom}$  | 300   |      | A                |   |
| $V_{GES}$                 |  | $\pm 20$  |      | V                |   |
| $t_{psc}$                 | $V_{CC} = 600\text{ V}; V_{GE} \leq 20\text{ V}; T_j = 125^\circ\text{C}$<br>$V_{CES} < 1200\text{ V}$ | 10  |      | $\mu\text{s}$    |   |
| <b>Inverse Diode</b>      |  |   |      |                  |   |
| $I_F$                     | $T_j = 150^\circ\text{C}$  | $T_{case} = 25^\circ\text{C}$                         | 200  |                  | A |
|                           |  | $T_{case} = 80^\circ\text{C}$                         | 130  |                  | A |
| $I_{FRM}$                 | $I_{FRM} = 2 \times I_{Fnom}$  | 300   |      | A                |   |
| $I_{FSM}$                 | $t_p = 10\text{ ms}; \sin.$  | $T_j = 150^\circ\text{C}$                             | 1440 |                  | A |
| <b>Freewheeling Diode</b> |  |   |      |                  |   |
| $I_F$                     | $T_j = ^\circ\text{C}$   | $T_c = 25^\circ\text{C}$                              | 200  |                  | A |
|                           |  | $T_c = 80^\circ\text{C}$                              | 130  |                  | A |
| $I_{FRM}$                 | $I_{FRM} = 2 \times I_{Fnom}$  | 300   |      | A                |   |
| $I_{FSM}$                 | $t_p = 10\text{ ms};$  | $T_j = 150^\circ\text{C}$                             | 1440 |                  | A |
| <b>Module</b>             |  |   |      |                  |   |
| $I_{t(RMS)}$              |  | 500   |      | A                |   |
| $T_{vj}$                  |  | - 40...+ 150  |      | $^\circ\text{C}$ |   |
| $T_{stg}$                 |  | - 40...+ 125  |      | $^\circ\text{C}$ |   |
| $V_{isol}$                | AC, 1 min.   | 4000  |      | V                |   |

| Characteristics |   | $T_c = 25^\circ\text{C}$ , unless otherwise specified   |      |      |                  |
|-----------------|---|---|------|------|------------------|
| Symbol          | Conditions                                      | min.  | typ. | max. | Units            |
| <b>IGBT</b>     |   |   |      |      |                  |
| $V_{GE(th)}$    | $V_{GE} = V_{CE}, I_C = 6\text{ mA}$            | 4,5   | 5,5  | 6,5  | V                |
| $I_{CES}$       | $V_{GE} = 0\text{ V}, V_{CE} = V_{CES}$         |   | 0,15 | 0,45 | mA               |
| $V_{CE0}$       |   | $T_j = 25^\circ\text{C}$                                | 1,5  |      | V                |
|                 |   | $T_j = 125^\circ\text{C}$                               | 1,75 |      | V                |
| $r_{CE}$        | $V_{GE} = 15\text{ V}$                          | $T_j = 25^\circ\text{C}$                                | 12   |      | $\text{m}\Omega$ |
|                 |   | $T_j = 125^\circ\text{C}$                               | 14   |      | $\text{m}\Omega$ |
| $V_{CE(sat)}$   | $I_{Cnom} = 150\text{ A}, V_{GE} = 15\text{ V}$ |   | 3,3  | 3,85 | V                |
| $C_{ies}$       |   |   | 10   | 13   | nF               |
| $C_{oes}$       | $V_{CE} = 25, V_{GE} = 0\text{ V}$              |   | 1,5  | 2    | nF               |
| $C_{res}$       | $f = 1\text{ MHz}$                              |   | 0,8  | 1,2  | nF               |
| $Q_G$           | $V_{GE} = 0\text{ V} - +20\text{ V}$            |   | 1300 |      | nC               |
| $R_{Gint}$      | $T_j = ^\circ\text{C}$                          |   | 2,5  |      | $\Omega$         |
| $t_{d(on)}$     | $R_{Gon} = 4\ \Omega$                           | $V_{CC} = 600\text{ V}$<br>$I_C = 150\text{ A}$         | 75   |      | ns               |
| $t_r$           |   |   | 36   |      | ns               |
| $E_{on}$        | $R_{Goff} = 4\ \Omega$                          | $T_j = 125^\circ\text{C}$<br>$V_{GE} = \pm 15\text{ V}$ | 14   |      | mJ               |
| $t_{d(off)}$    |   |   | 420  |      | ns               |
| $t_f$           |   |   | 25   |      | ns               |
| $E_{off}$       |   |   |      |      | mJ               |
| $R_{th(j-c)}$   | per IGBT  |   | 0,09 |      | K/W              |



**SEMITRANS® 3**

## Ultra Fast IGBT Modules

**SKM 200GB125D**

**SKM 200GAL125D**

**SKM 200GAR125D**

### Features

- N channel , homogeneous Si
- Low inductance case
- Short tail current with low temperature dependence
- High short circuit capability, self limiting to  $6 \times I_{cnom}$
- Fast & soft inverse CAL diodes
- Isolated copper baseplate using DCB Direct Copper Bonding Technology
- Large clearance (13 mm) and creepage distance (20 mm)

### Typical Applications\*

- Switched mode power supplies at  $f_{sw} > 20$  kHz
- Resonant inverters up to 100 kHz
- Inductive heating
- Electronic welders at  $f_{sw} > 20$  kHz

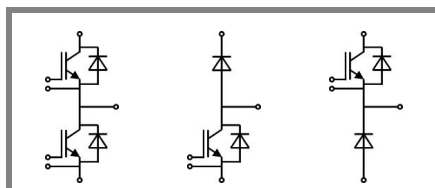

GB

GAL

GAR

| Characteristics           |                                    |                                    |      |       |       |
|---------------------------|------------------------------------|------------------------------------|------|-------|-------|
| Symbol                    | Conditions                         | min.                               | typ. | max.  | Units |
| <b>Inverse Diode</b>      |                                    |                                    |      |       |       |
| $V_F = V_{EC}$            | $I_{Fnom} = 150$ A; $V_{GE} = 0$ V | $T_j = 25$ °C <sub>chiplev.</sub>  | 2    | 2,5   | V     |
|                           |                                    | $T_j = 125$ °C <sub>chiplev.</sub> | 1,8  |       | V     |
| $V_{F0}$                  |                                    | $T_j = 25$ °C                      | 1,1  | 1,2   | V     |
|                           |                                    | $T_j = 125$ °C                     |      |       | V     |
| $r_F$                     |                                    | $T_j = 25$ °C                      | 6    | 8,7   | mΩ    |
|                           |                                    | $T_j = 125$ °C                     |      |       | mΩ    |
| $I_{RRM}$                 | $I_F = 150$ A                      | $T_j = 125$ °C                     | 230  |       | A     |
| $Q_{rr}$                  | $di/dt = 5500$ A/μs                |                                    | 24   |       | μC    |
| $E_{rr}$                  | $V_{GE} = 0$ V; $V_{CC} = 600$ V   |                                    |      |       | mJ    |
| $R_{th(j-c)D}$            | per diode                          |                                    |      | 0,25  | K/W   |
| <b>Freewheeling Diode</b> |                                    |                                    |      |       |       |
| $V_F = V_{EC}$            | $I_{Fnom} = 150$ A; $V_{GE} = 0$ V | $T_j = 25$ °C <sub>chiplev.</sub>  | 2    | 2,5   | V     |
|                           |                                    | $T_j = 125$ °C <sub>chiplev.</sub> | 1,8  |       | V     |
| $V_{F0}$                  |                                    | $T_j = 25$ °C                      | 1,1  | 1,2   | V     |
|                           |                                    | $T_j = 125$ °C                     |      |       | V     |
| $r_F$                     |                                    | $T_j = 25$ °C                      | 6    | 8,7   | V     |
|                           |                                    | $T_j = 125$ °C                     |      |       | V     |
| $I_{RRM}$                 | $I_F = 150$ A                      | $T_j = 125$ °C                     | 230  |       | A     |
| $Q_{rr}$                  | $di/dt = 5500$ A/μs                |                                    | 24   |       | μC    |
| $E_{rr}$                  | $V_{GE} = 0$ V; $V_{CC} = 600$ V   |                                    |      |       | mJ    |
| $R_{th(j-c)FD}$           | per diode                          |                                    |      | 0,25  | K/W   |
| <b>Module</b>             |                                    |                                    |      |       |       |
| $L_{CE}$                  |                                    |                                    | 15   | 20    | nH    |
| $R_{CC'+EE'}$             | res., terminal-chip                | $T_{case} = 25$ °C                 | 0,35 |       | mΩ    |
|                           |                                    | $T_{case} = 125$ °C                | 0,5  |       | mΩ    |
| $R_{th(c-s)}$             | per module                         |                                    |      | 0,038 | K/W   |
| $M_s$                     | to heat sink M6                    |                                    | 3    | 5     | Nm    |
| $M_t$                     | to terminals M6                    |                                    | 2,5  | 5     | Nm    |
| w                         |                                    |                                    |      | 325   | g     |

This is an electrostatic discharge sensitive device (ESDS), international standard IEC 60747-1, Chapter IX.

\* The specifications of our components may not be considered as an assurance of component characteristics. Components have to be tested for the respective application. Adjustments may be necessary. The use of SEMIKRON products in life support appliances and systems is subject to prior specification and written approval by SEMIKRON. We therefore strongly recommend prior consultation of our personal.

# SKM 200GB125D



**SEMITRANS® 3**

## Ultra Fast IGBT Modules

**SKM 200GB125D**

**SKM 200GAL125D**

**SKM 200GAR125D**

### Features

- N channel , homogeneous Si
- Low inductance case
- Short tail current with low temperature dependence
- High short circuit capability, self limiting to  $6 \times I_{cnom}$
- Fast & soft inverse CAL diodes
- Isolated copper baseplate using DCB Direct Copper Bonding Technology
- Large clearance (13 mm) and creepage distance (20 mm)

### Typical Applications\*

- Switched mode power supplies at  $f_{sw} > 20$  kHz
- Resonant inverters up to 100 kHz
- Inductive heating
- Electronic welders at  $f_{sw} > 20$  kHz

| $Z_{th}$                         |         | Conditions | Values | Units |
|----------------------------------|---------|------------|--------|-------|
| <b><math>Z_{th(j-c)I}</math></b> |         |            |        |       |
| $R_{\theta j-c}$                 | $i = 1$ |            | 60     | mk/W  |
| $R_{\theta j-c}$                 | $i = 2$ |            | 23     | mk/W  |
| $R_{\theta j-c}$                 | $i = 3$ |            | 5,9    | mk/W  |
| $R_{\theta j-c}$                 | $i = 4$ |            | 1,1    | mk/W  |
| $\tau_{th(j-c)}$                 | $i = 1$ |            | 0,0744 | s     |
| $\tau_{th(j-c)}$                 | $i = 2$ |            | 0,0087 | s     |
| $\tau_{th(j-c)}$                 | $i = 3$ |            | 0,002  | s     |
| $\tau_{th(j-c)}$                 | $i = 4$ |            | 0,0015 | s     |
| <b><math>Z_{th(j-c)D}</math></b> |         |            |        |       |
| $R_{\theta j-c}$                 | $i = 1$ |            | 160    | mk/W  |
| $R_{\theta j-c}$                 | $i = 2$ |            | 67     | mk/W  |
| $R_{\theta j-c}$                 | $i = 3$ |            | 20     | mk/W  |
| $R_{\theta j-c}$                 | $i = 4$ |            | 3      | mk/W  |
| $\tau_{th(j-c)}$                 | $i = 1$ |            | 0,0536 | s     |
| $\tau_{th(j-c)}$                 | $i = 2$ |            | 0,0034 | s     |
| $\tau_{th(j-c)}$                 | $i = 3$ |            | 0,077  | s     |
| $\tau_{th(j-c)}$                 | $i = 4$ |            | 0,0003 | s     |

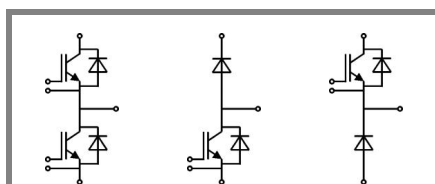

**GB**

**GAL**

**GAR**

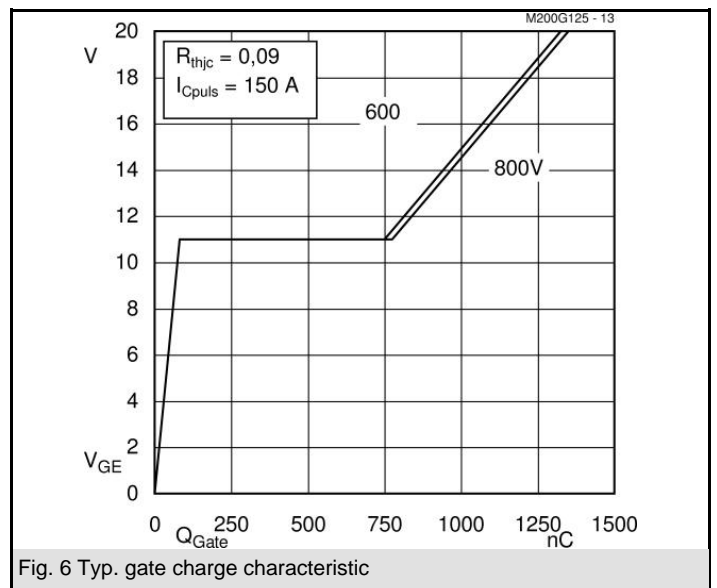
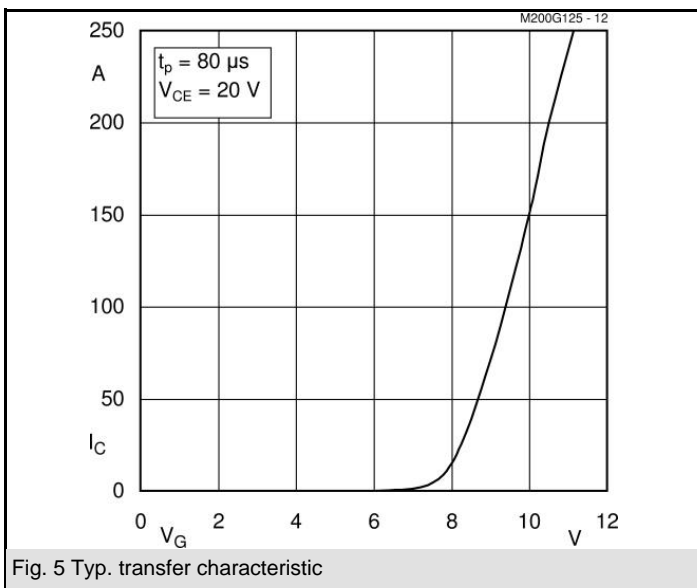
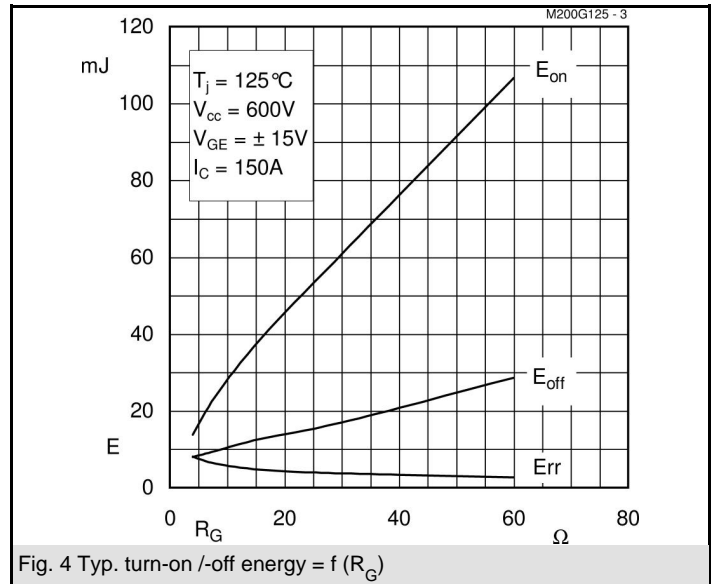
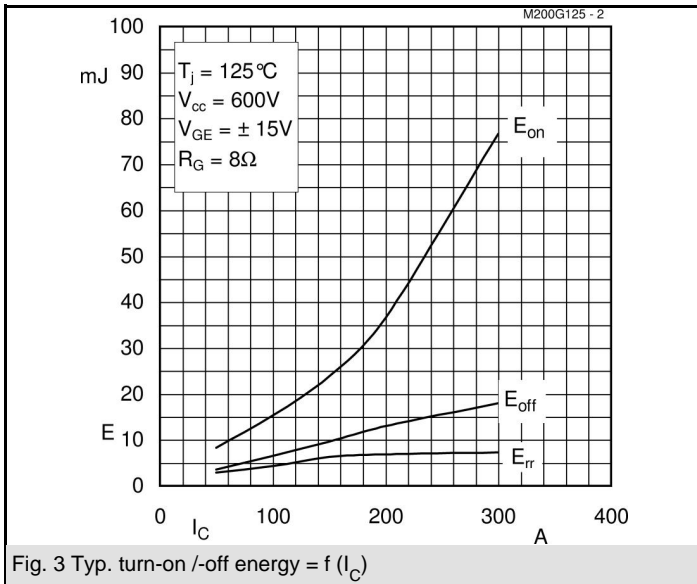
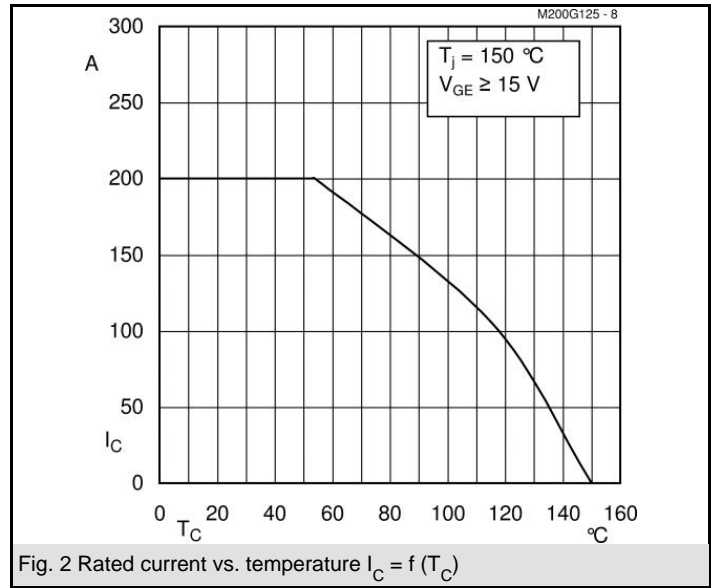
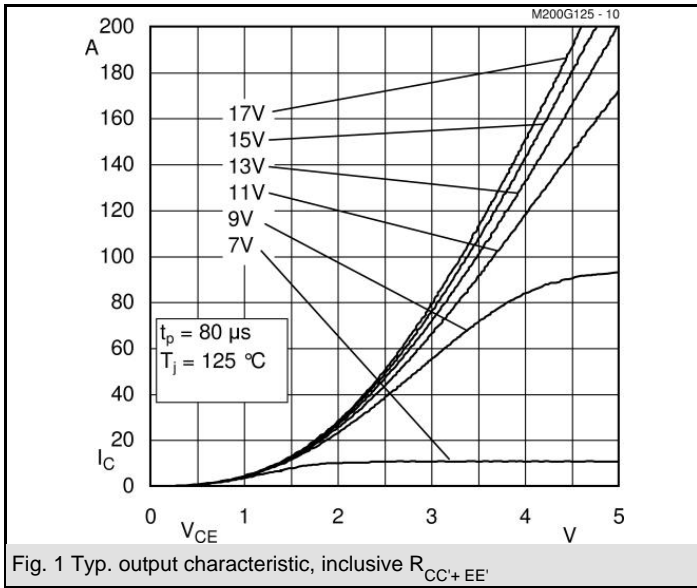

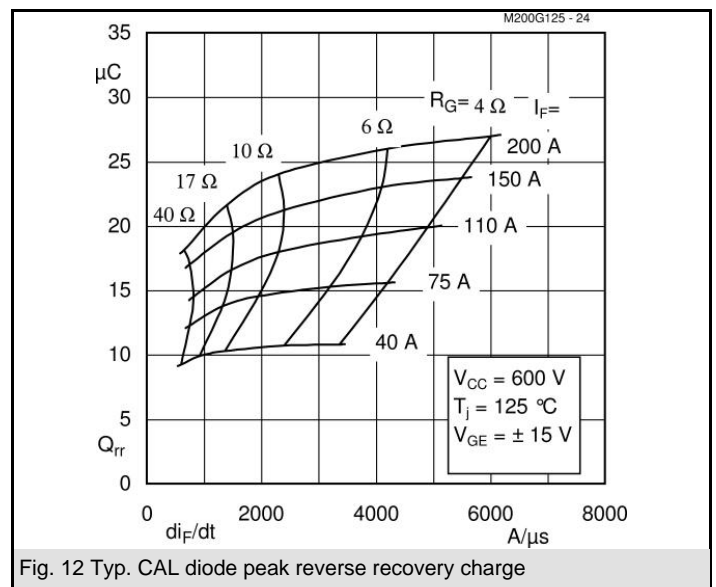
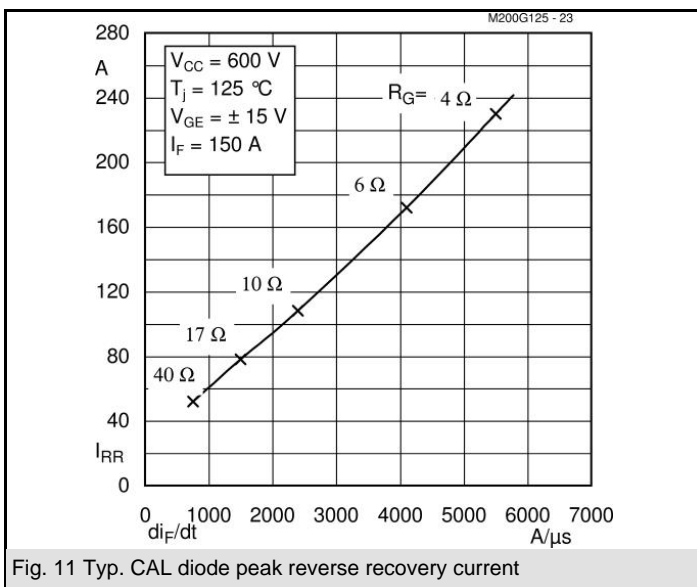
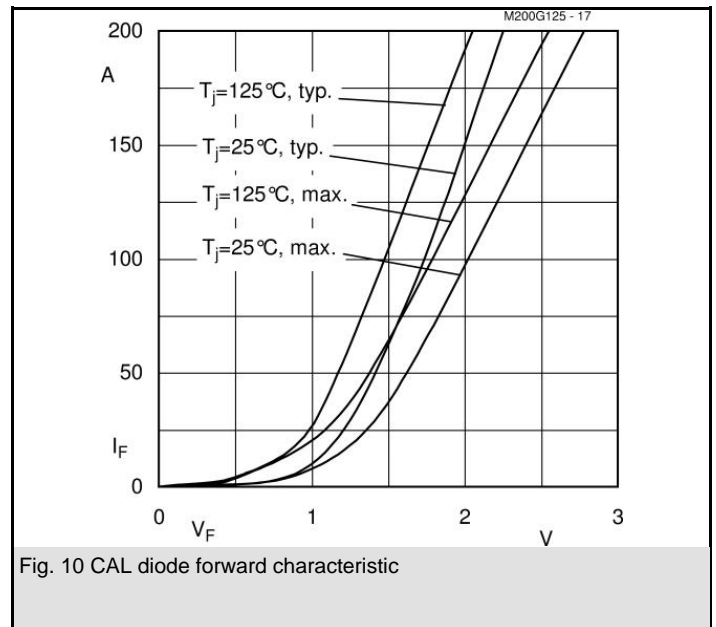
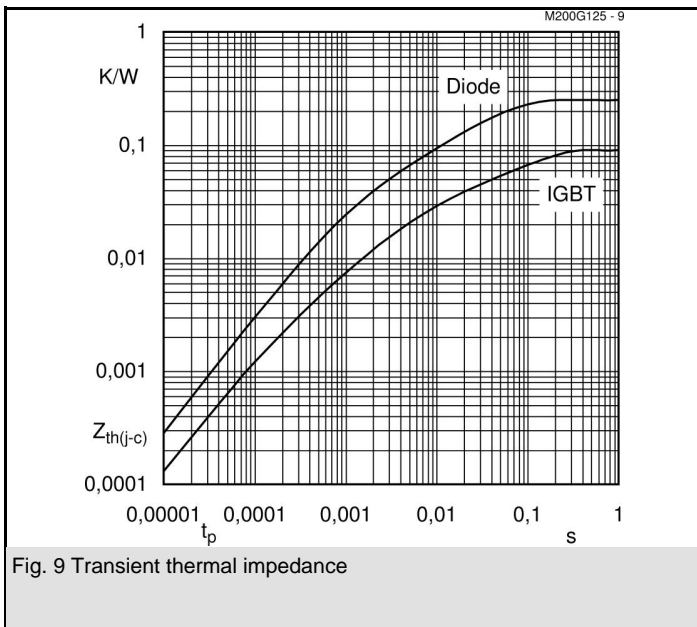
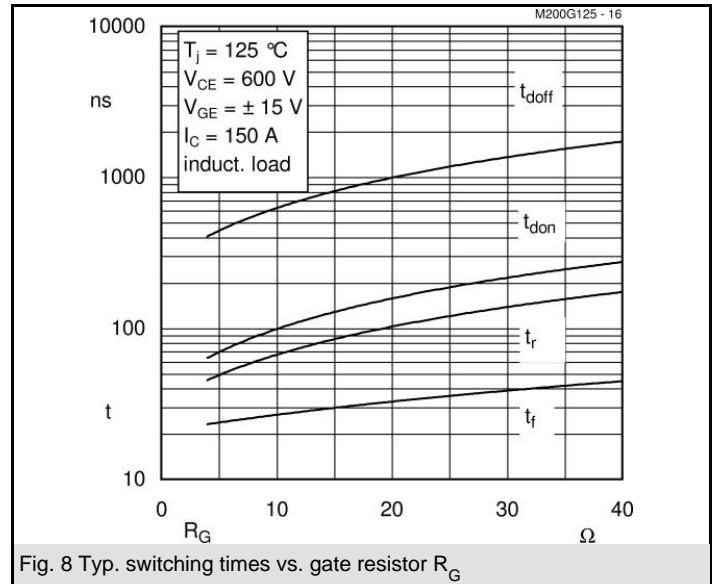
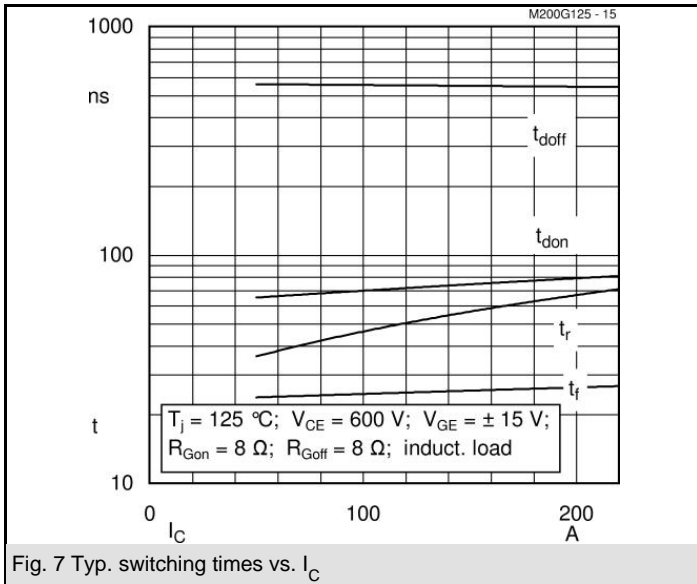

# SKM 200GB125D

UL Recognized

CASED56

File 63 532

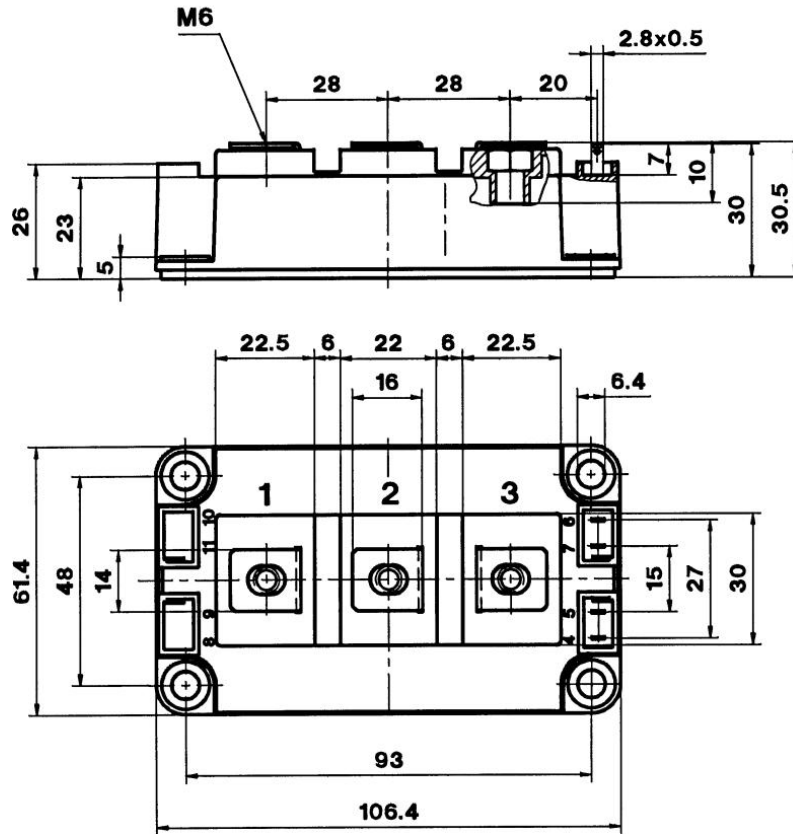

Case D 56



GB Case D 56

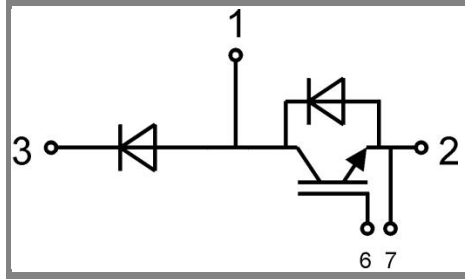

GAL Case D 57 (→ D 56)

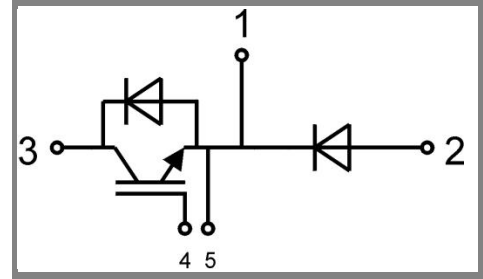

GAR Case D 58 (→ D 56)