MiniSKiiP[®]0

3-phase bridge inverter

SKiiP 02AC066V1

Preliminary Data

Features

- Trench IGBTs
- Robust and soft freewheeling diodes in CAL technology
- Highly reliable spring contacts for electrical connections
- UL recognised file no. E63532

Typical Applications*

- Inverter up to 5 kVA
- Typical motor power 2,2 kW

Remarks

- Case temperature limited to $T_C = 125^\circ\text{C}$ max., product reliability results are valid for $T_j = 150^\circ\text{C}$
- SC data: $t_p \leq 6 \mu\text{s}$; $V_{GE} \leq 15 \text{ V}$; $T_j = 150^\circ\text{C}$; $V_{CC} = 360 \text{ V}$
- V_{CEsat} , $V_F =$ chip level value
- Temp. Sensor: No basic insulation to main circuit, max. potential difference 850V to -DC

Absolute Maximum Ratings		$T_S = 25^\circ\text{C}$, unless otherwise specified	
Symbol	Conditions	Values	Units
IGBT - Inverter			
V_{CES}		600	V
I_C	$T_S = 25 (70)^\circ\text{C}, T_j = 150^\circ\text{C}$	17 (14)	A
I_C	$T_S = 25 (70)^\circ\text{C}, T_j = 175^\circ\text{C}$	20 (16)	A
I_{CRM}	$t_p = 1 \text{ ms}$	20	A
V_{GES}		± 20	V
T_j		-40...+175	$^\circ\text{C}$
Diode - Inverter			
I_F	$T_S = 25 (70)^\circ\text{C}, T_j = 150^\circ\text{C}$	20 (15)	A
I_F	$T_S = 25 (70)^\circ\text{C}, T_j = 175^\circ\text{C}$	20 (18)	A
I_{FRM}	$t_p = 1 \text{ ms}$	20	A
T_j		-40...+175	$^\circ\text{C}$
I_{RMS}	per power terminal (20 A / spring)	20	A
T_{stg}	$T_{op} \leq T_{stg}$	-40...+125	$^\circ\text{C}$
V_{isol}	AC, 1 min.	2500	V

Characteristics		$T_S = 25^\circ\text{C}$, unless otherwise specified			
Symbol	Conditions	min.	typ.	max.	Units
IGBT - Inverter					
V_{CEsat}	$I_{Cnom} = 10 \text{ A}, T_j = 25 (150)^\circ\text{C}$	1,1	1,45 (1,65)	1,85 (2,05)	V
$V_{GE(th)}$	$V_{GE} = V_{CE}, I_C = 1 \text{ mA}$		5,8		V
$V_{CE(TO)}$	$T_j = 25 (150)^\circ\text{C}$		0,9 (0,7)	1,1 (1)	V
r_T	$T_j = 25 (150)^\circ\text{C}$		60 (100)	80 (110)	m Ω
C_{ies}	$V_{CE} = 25 \text{ V}, V_{GE} = 0 \text{ V}, f = 1 \text{ MHz}$		0,58		nF
C_{oes}	$V_{CE} = 25 \text{ V}, V_{GE} = 0 \text{ V}, f = 1 \text{ MHz}$		0,12		nF
C_{res}	$V_{CE} = 25 \text{ V}, V_{GE} = 0 \text{ V}, f = 1 \text{ MHz}$		0,06		nF
$R_{CC'+EE'}$	spring contact-chip $T_S = 25 (150)^\circ\text{C}$				m Ω
$R_{th(j-s)}$	per IGBT		2		K/W
$t_{d(on)}$	under following conditions		28		ns
t_r	$V_{CC} = 300 \text{ V}, V_{GE} = -15\text{V}/+15\text{V}$		30		ns
$t_{d(off)}$	$I_{Cnom} = 10 \text{ A}, T_j = 150^\circ\text{C}$		190		ns
t_f	$R_{Gon} = R_{Goff} = 39 \Omega$		37		ns
$E_{on}(E_{off})$	inductive load		0,45 (0,3)		mJ
Diode - Inverter					
$V_F = V_{EC}$	$I_{Fnom} = 10 \text{ A}, T_j = 25 (150)^\circ\text{C}$		1,3 (1,3)	1,6 (1,6)	V
$V_{(TO)}$	$T_j = 25 (150)^\circ\text{C}$		0,9 (0,8)	1 (0,9)	V
r_T	$T_j = 25 (150)^\circ\text{C}$		40 (50)	60 (70)	m Ω
$R_{th(j-s)}$	per diode		2,5		K/W
I_{RRM}	under following conditions		13,5		A
Q_{rr}	$I_{Fnom} = 10 \text{ A}, V_R = 300 \text{ V}$		1,3		μC
E_{rr}	$V_{GE} = 0 \text{ V}, T_j = 150^\circ\text{C}$		0,3		mJ
	$di_F/dt = 600 \text{ A}/\mu\text{s}$				
Temperature Sensor					
R_{ts}	3 %, $T_r = 25 (100)^\circ\text{C}$		1000(1670)		Ω
Mechanical Data					
m			21,5		g
M_s	Mounting torque	2		2,5	Nm

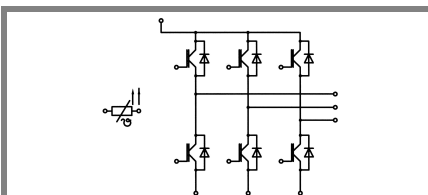

AC

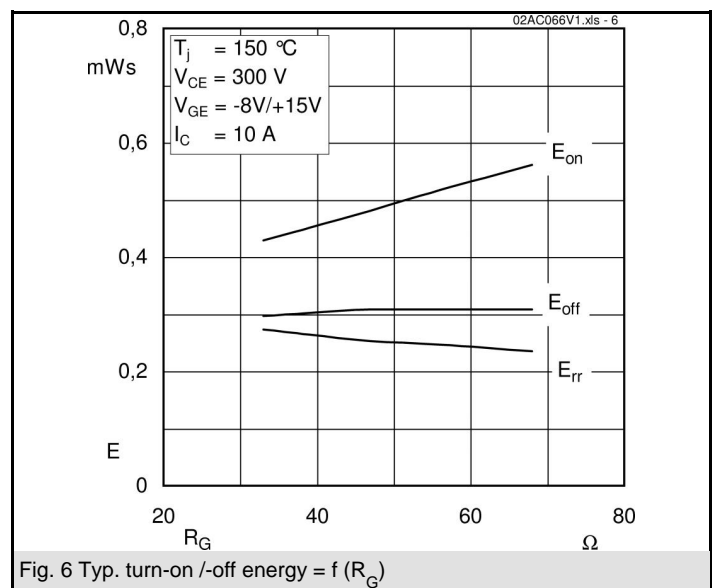
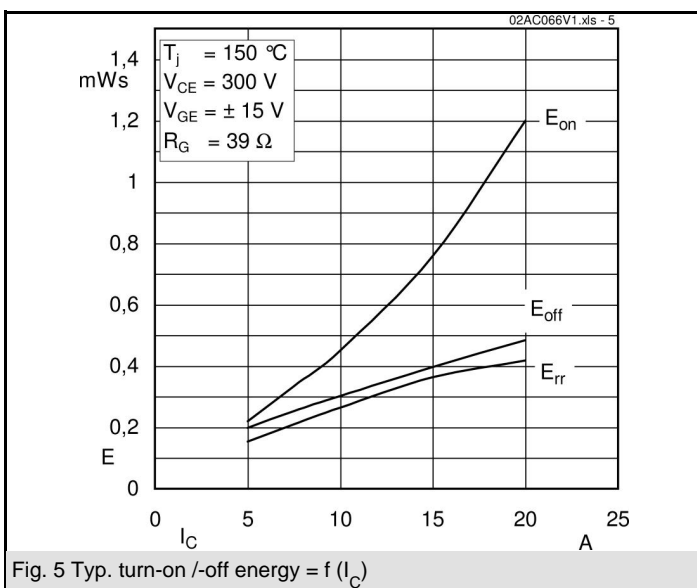
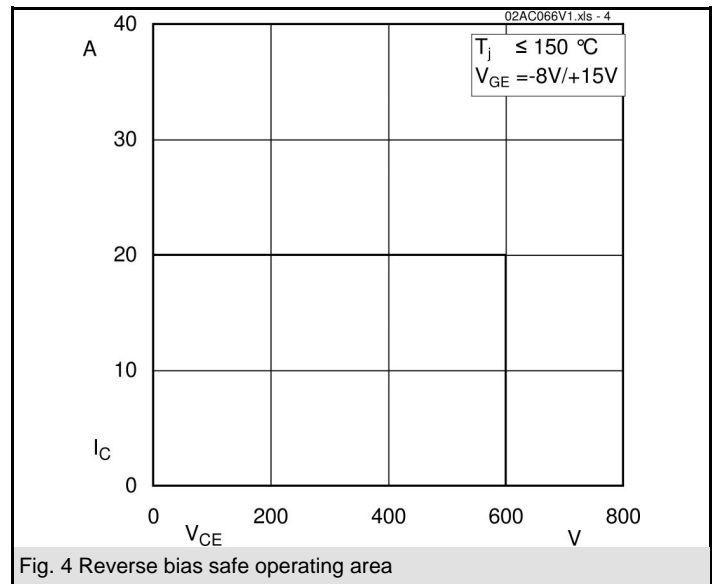
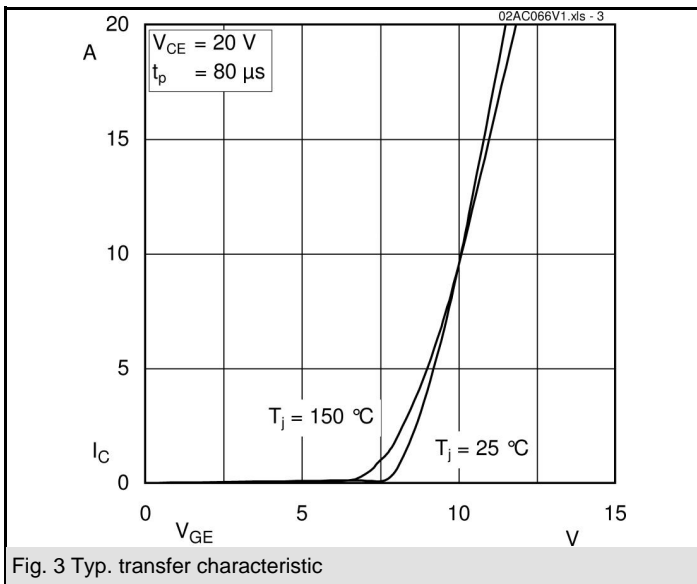
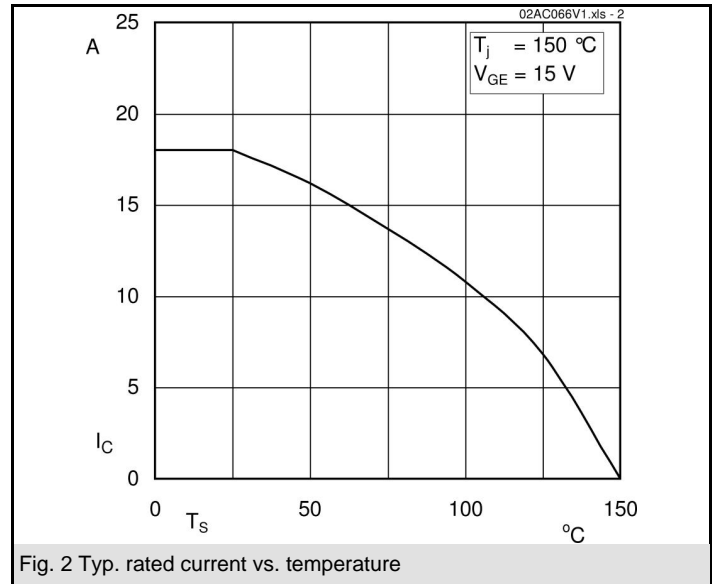
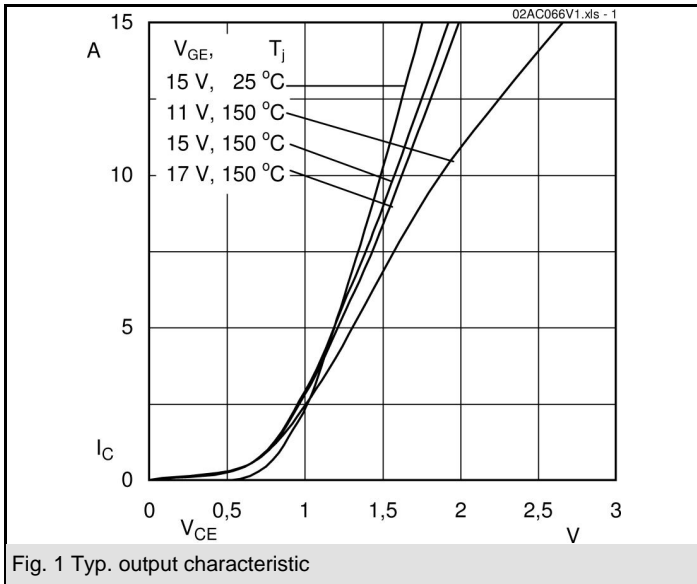

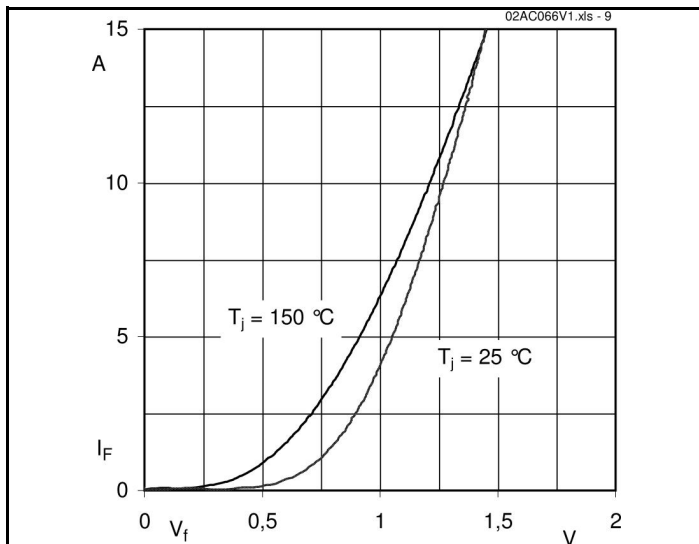
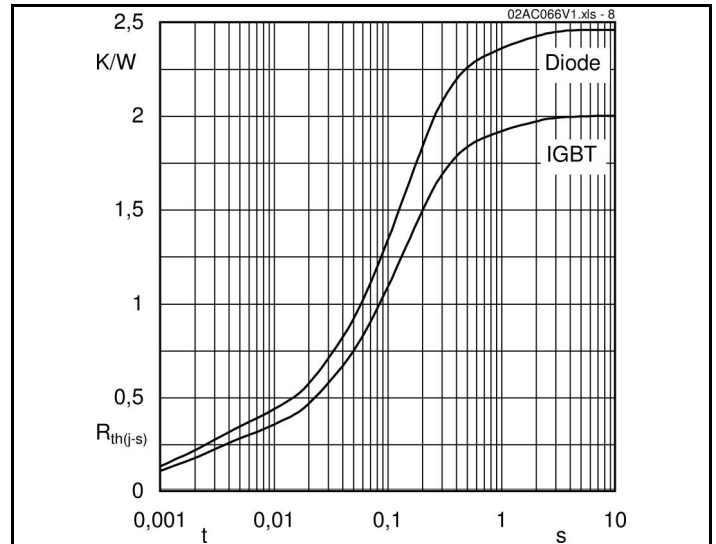
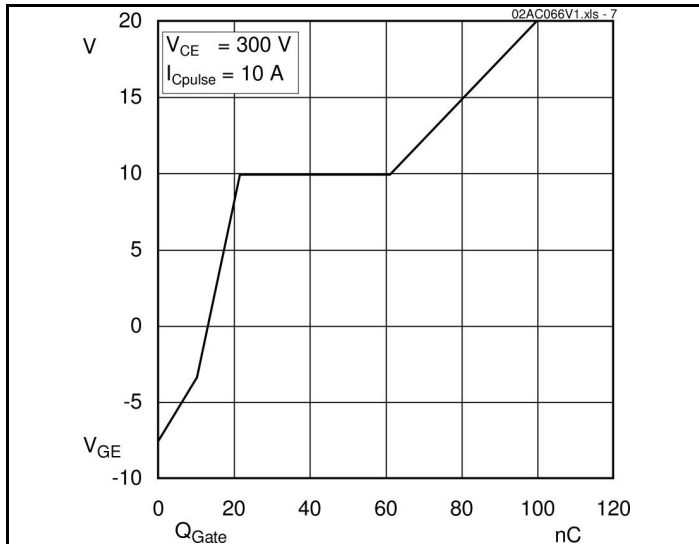

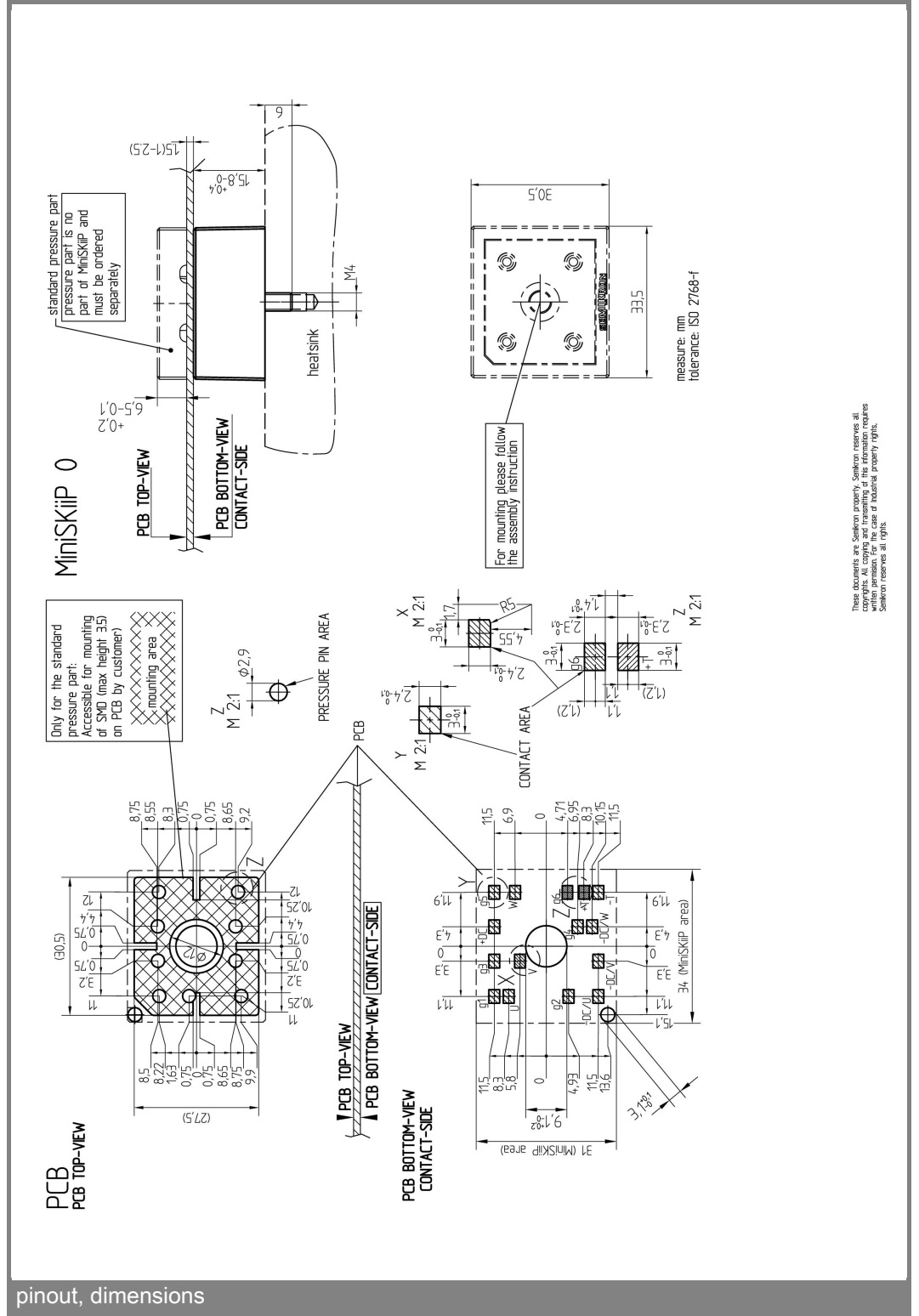
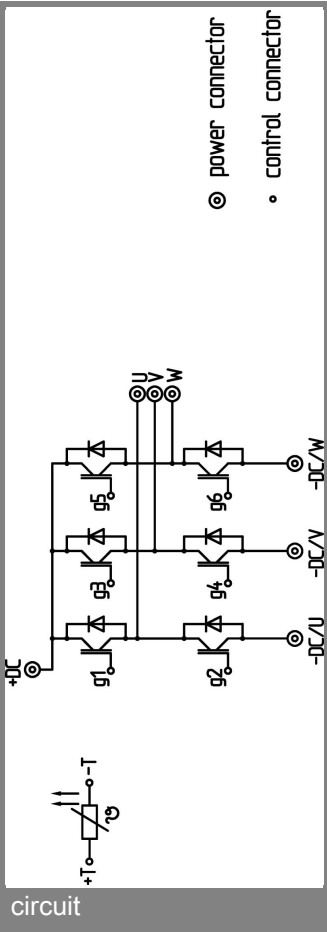

This is an electrostatic discharge sensitive device (ESDS), international standard IEC 60747-1, Chapter IX.

* The specifications of our components may not be considered as an assurance of component characteristics. Components have to be tested for the respective application. Adjustments may be necessary. The use of SEMIKRON products in life support appliances and systems is subject to prior specification and written approval by SEMIKRON. We therefore strongly recommend prior consultation of our personal.