

> **Features**

- High Current
- Low On-Resistance
- No Secondary Breakdown
- Low Driving Power
- Avalanche Rated

> **Applications**

- Motor Control
- General Purpose Power Amplifier
- DC-DC converters

> **Outline Drawing**

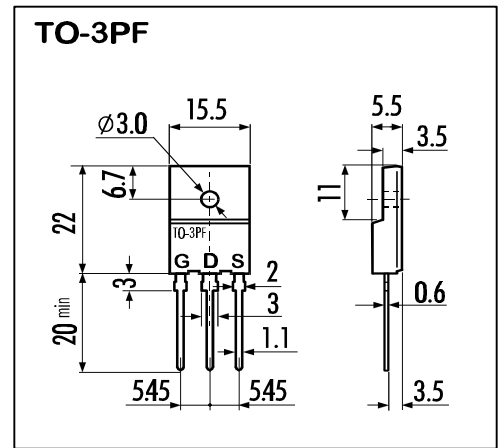

> **Maximum Ratings and Characteristics**

- Absolute Maximum Ratings (T<sub>C</sub>=25°C), unless otherwise specified

Item	Symbol	Rating	Unit
Drain-Source-Voltage	V <sub>DS</sub>	30	V
Continous Drain Current	I <sub>D</sub>	±90	A
Pulsed Drain Current	I <sub>D(puls)</sub>	±350	A
Gate-Source-Voltage	V <sub>GS</sub>	±16	V
Maximum Avalanche Energy	E <sub>AV</sub>	1728.5	mJ*
Max. Power Dissipation	P <sub>D</sub>	100	W
Operating and Storage Temperature Range	T <sub>ch</sub>	150	°C
	T <sub>stg</sub>	-55 ~ +150	°C

L=0.285mH, V<sub>CC</sub>=12V

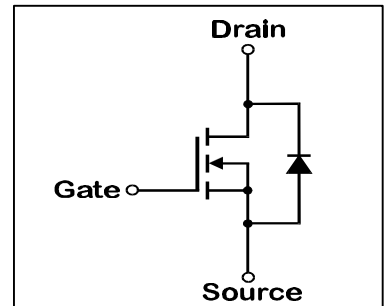

- Electrical Characteristics (T<sub>C</sub>=25°C), unless otherwise specified

Item	Symbol	Test conditions	Min.	Typ.	Max.	Unit
Drain-Source Breakdown-Voltage	BV <sub>DSS</sub>	I <sub>D</sub> =1mA V <sub>GS</sub> =0V	30			V
Gate Threshold Voltage	V <sub>GS(th)</sub>	I <sub>D</sub> =1mA V <sub>DS</sub> =V <sub>GS</sub>	1,0	1,5	2,0	V
Zero Gate Voltage Drain Current	I <sub>DSS</sub>	V <sub>DS</sub> =30V T <sub>ch</sub> =25°C		10	500	μA
		V <sub>GS</sub> =0V T <sub>ch</sub> =125°C		0,2	1,0	mA
Gate Source Leakage Current	I <sub>GSS</sub>	V <sub>GS</sub> =±16V V <sub>DS</sub> =0V		10	100	nA
Drain Source On-State Resistance	R <sub>DS(on)</sub>	I <sub>D</sub> =50A V <sub>GS</sub> =4V		7,0	9,5	mΩ
		I <sub>D</sub> =50A V <sub>GS</sub> =10V		4,4	5,5	mΩ
Forward Transconductance	g <sub>fs</sub>	I <sub>D</sub> =50A V <sub>DS</sub> =25V	35	70		S
Input Capacitance	C <sub>iss</sub>	V <sub>DS</sub> =25V		3900	5850	pF
Output Capacitance	C <sub>oss</sub>	V <sub>GS</sub> =0V		2000	3000	pF
Reverse Transfer Capacitance	C <sub>rss</sub>	f=1MHz		850	1280	pF
Turn-On-Time t <sub>on</sub> (t <sub>on</sub> =t <sub>d(on)</sub> +t <sub>r</sub> )	t <sub>d(on)</sub>	V <sub>CC</sub> =15V		17	30	ns
	t <sub>r</sub>	V <sub>GS</sub> =10V		70	110	ns
	t <sub>f</sub>	I <sub>D</sub> =100A R <sub>GS</sub> =10 Ω		250	380	ns
Turn-Off-Time t <sub>off</sub> (t <sub>off</sub> =t <sub>d(off)</sub> +t <sub>f</sub> )	t <sub>d(off)</sub>			180	270	ns
	t <sub>f</sub>					
Avalanche Capability	I <sub>AV</sub>	L = 100μH T <sub>ch</sub> =25°C	90			A
Diode Forward On-Voltage	V <sub>SD</sub>	I <sub>F</sub> =50A V <sub>GS</sub> =0V T <sub>ch</sub> =25°C		1,0	1,5	V
Reverse Recovery Time	t <sub>rr</sub>	I <sub>F</sub> =50A V <sub>GS</sub> =0V		65		ns
Reverse Recovery Charge	Q <sub>rr</sub>	-di/dt=100A/μs T <sub>ch</sub> =25°C		0,12		μC

- Thermal Characteristics

Item	Symbol	Min.	Typ.	Max.	Unit
Thermal Resistance	R <sub>th(ch-c)</sub>			1,25	°C/W
	R <sub>th(ch-a)</sub>			30,0	°C/W

N-channel MOS-FET			
30V	5.5mΩ	±90A	100W

# 2SK2892-01R

## FAP-IIIB Series



### > Characteristics

Typical Output Characteristics

$I_D = f(V_{GS})$ ; 80μs pulse test;  $T_{ch} = 25^\circ\text{C}$

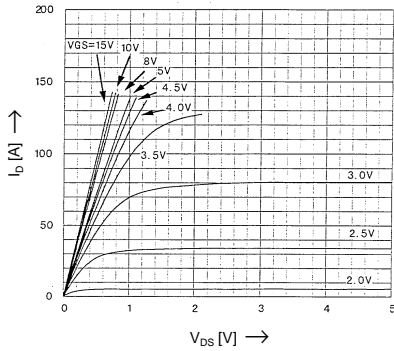

Drain-Source On-State Resistance vs.  $T_{ch}$

$R_{DS(on)} = f(T_{ch})$ ;  $I_D = 50\text{A}$ ;  $V_{GS} = 10\text{V}$

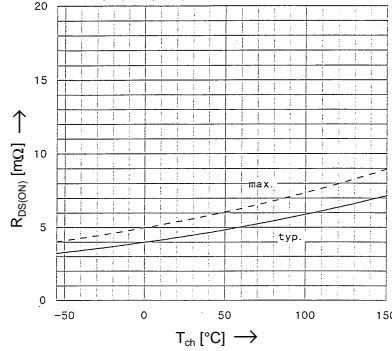

Typical Transfer Characteristics

$I_D = f(V_{GS})$ ; 80μs pulse test;  $V_{DS} = 25\text{V}$ ;  $T_{ch} = 25^\circ\text{C}$

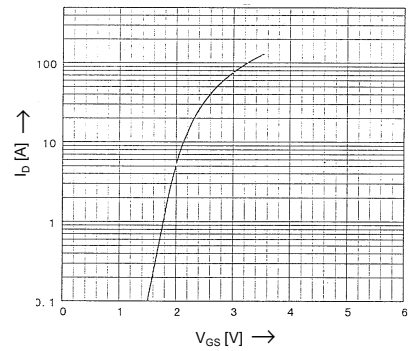

Typical Drain-Source On-State-Resistance vs.  $I_D$

$R_{DS(on)} = f(I_D)$ ; 80μs pulse test;  $T_{ch} = 25^\circ\text{C}$

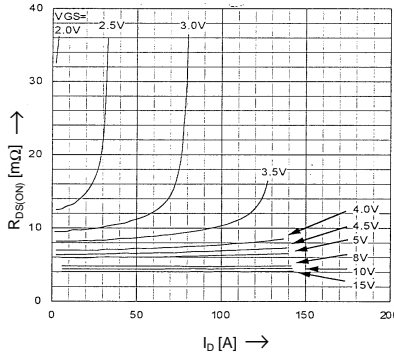

Typical Forward Transconductance vs.  $I_D$

$g_{fs} = f(I_D)$ ; 80μs pulse test;  $V_{DS} = 25\text{V}$ ;  $T_{ch} = 25^\circ\text{C}$

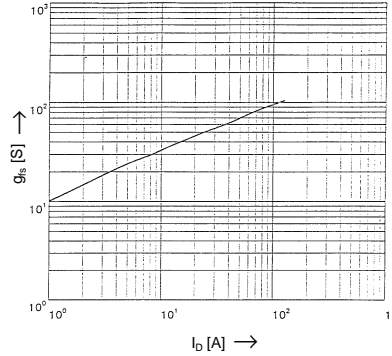

Gate Threshold Voltage vs.  $T_{ch}$

$V_{GS(th)} = f(T_{ch})$ ;  $I_D = 1\text{mA}$ ;  $V_{DS} = V_{GS}$

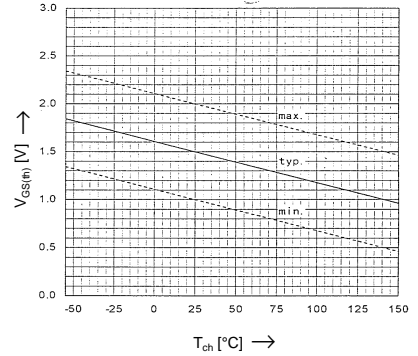

Typical Capacitances vs.  $V_{DS}$

$C = f(V_{DS})$ ;  $V_{GS} = 0\text{V}$ ;  $f = 1\text{MHz}$

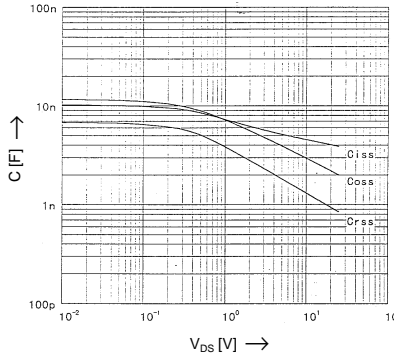

Typical Gate Charge Characteristic

$V_{GS} = f(Q_g)$ ;  $I_D = 100\text{A}$ ;  $T_{ch} = 25^\circ\text{C}$

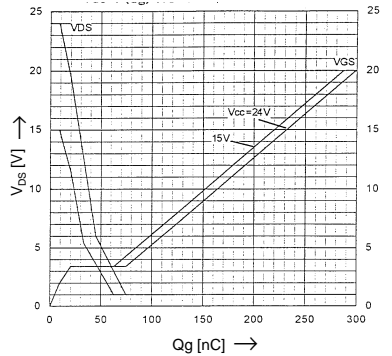

Forward Characteristics of Reverse Diode

$I_F = f(V_{SD})$ ; 80μs pulse test;  $T_{ch} = 25^\circ\text{C}$

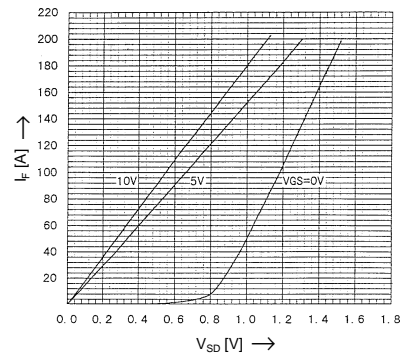

Maximum Avalanche Energy vs. starting  $T_{ch}$

$E_{as} = f(\text{starting } T_{ch})$ ;  $V_{CC} = 24\text{V}$ ;  $I_{AV} \leq 45\text{A}$

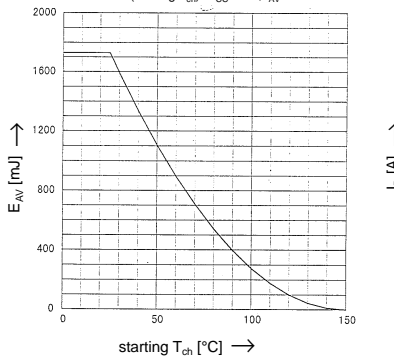

Safe Operation Area

$I_D = f(V_{DS})$ ;  $D = 0.01$ ;  $T_{ch} = 25^\circ\text{C}$

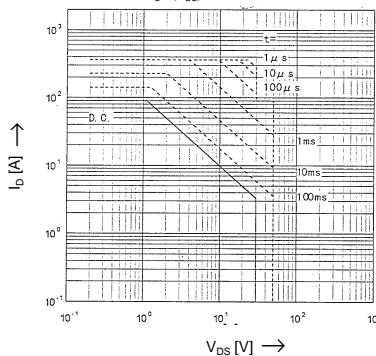

Transient Thermal Impedance

$Z_{th(ch-c)} = f(t)$  parameter:  $D \sim t$

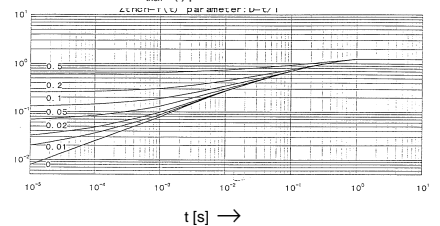

N-channel MOS-FET			
30V	5,5mΩ	±90A	100W

# 2SK2892-01R

## FAP-IIIB Series



### > Characteristics

